

### Unit Information

60Hz - 1440 Watts - 120 Volts  
Temperature range from 150°F - 205°F  
(66°C - 96°C)  
9 inch clearance between the drip tray  
and the spigot

# WARING COMMERCIAL

## 3 Gallon Hot Water Dispenser WWB3G

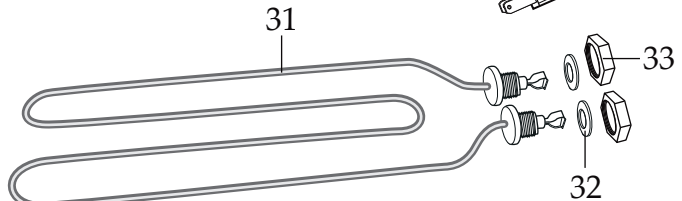
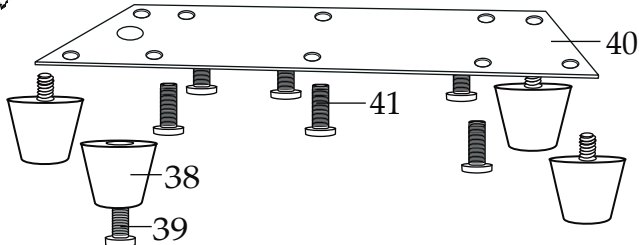
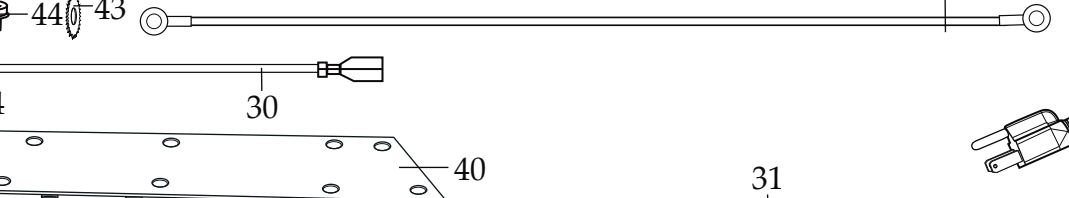
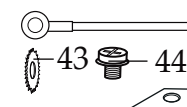
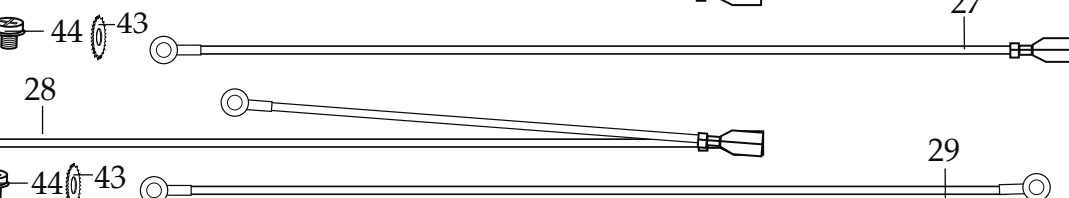
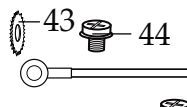
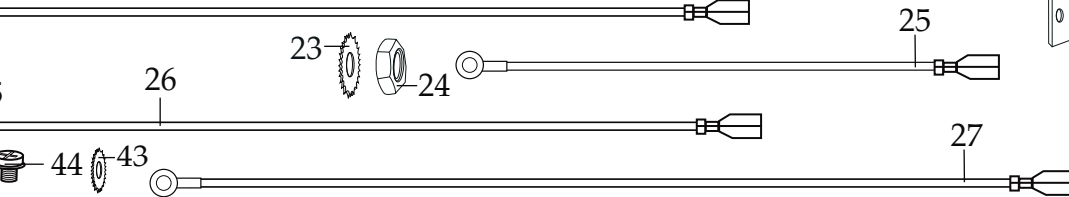
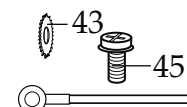
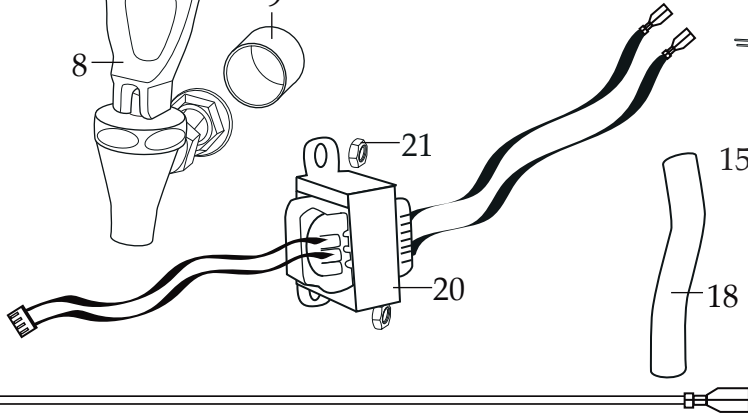
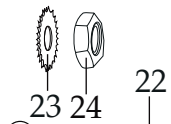
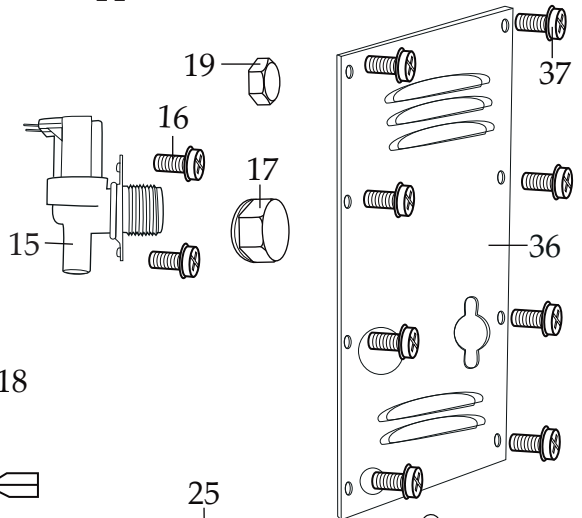
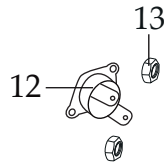
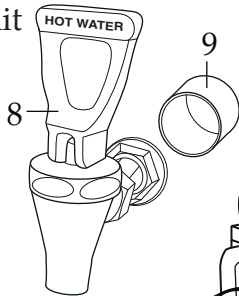
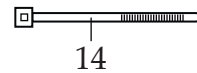
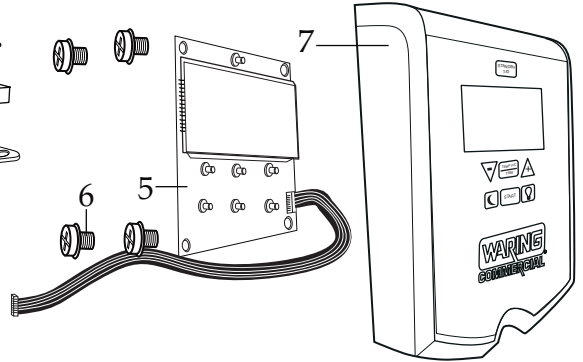
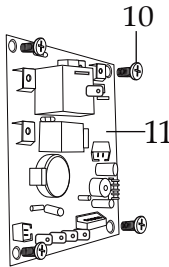
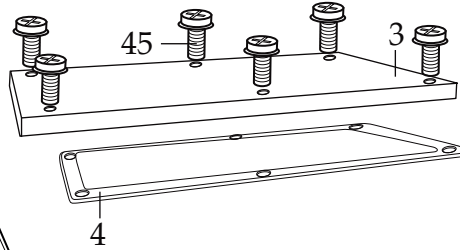
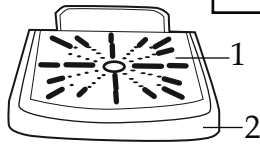
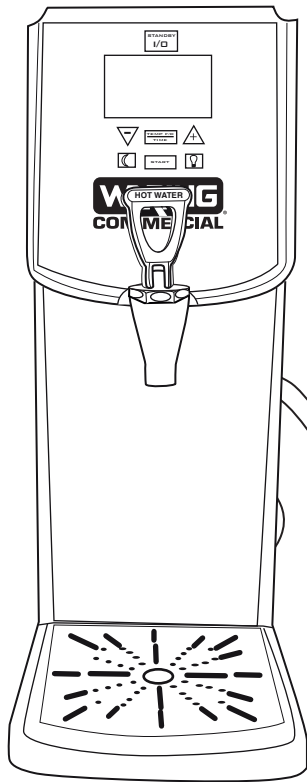

<b>Illustration#</b>	<b>Part#</b>	<b>Description</b>
1	037696	OverflowTray (metal)
2	037697	Overflow Tray (plastic)
3	037698	Tank Top Cover
4	037699	Tank Top Cover Gasket
5	037700	Control Board
6	037701	Screw (4 required)
7	037702	Control Panel
8	037149	Tap (spigot)
9	037703	Tap Ring
10	037163	Screw (4 required)
11	037704	PCB Board
12	037153	Thermal Cut Off
13	037154	Hex Nut (2 required)
14	013731	Wire Ties (5 required)
15	037165	Solenoid Valve
16	037717	Screw (2 required)
17	037705	Yellow Valve Cover
18	037706	Valve Tube
19	037707	Pipe Cover
20	037708	Transformer
21	037709	Hex Nut (2 required)
22	037710	12.5" Black Lead (2 required 1 ring and 1 regular terminal)
23	037175	Large Lock Washer
24	037711	Hex Nut
25	037712	8.75" Black Lead (1 ring and 1 regular terminal)
26	037713	12.5" Yellow /Green Lead (1 ring and 1 regular terminal)
27	037145	12.5" Red Lead (1 ring and 1 regular terminal)
28	037714	Double Blue Lead (2 ring and 1 regular terminal)
29	037144	12.5" Burgundy Lead (2 ring terminals)
30	037142	8.75" Burgundy Lead (1 ring and regular terminal)
31	037715	Heating Element
32	037169	Element Seal (2 required)

# WARING COMMERCIAL

Unit Components  
WWB3G

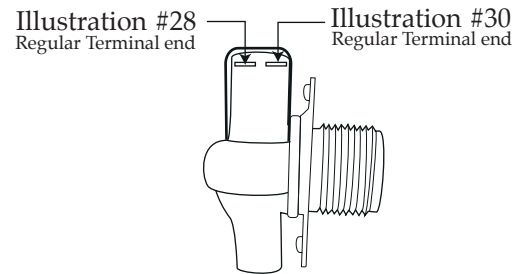
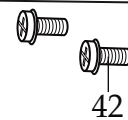
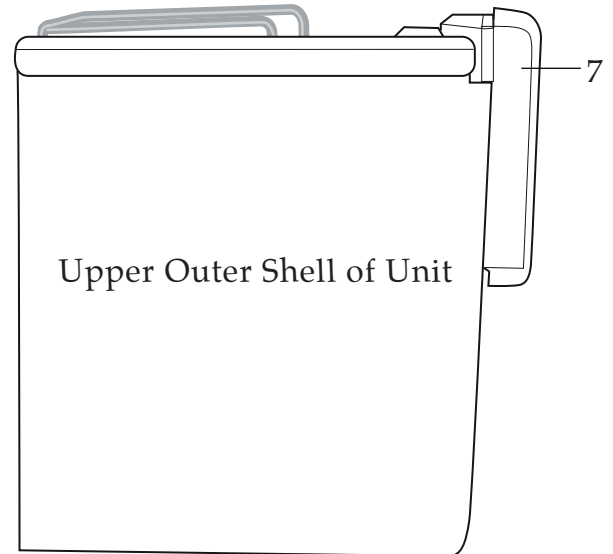
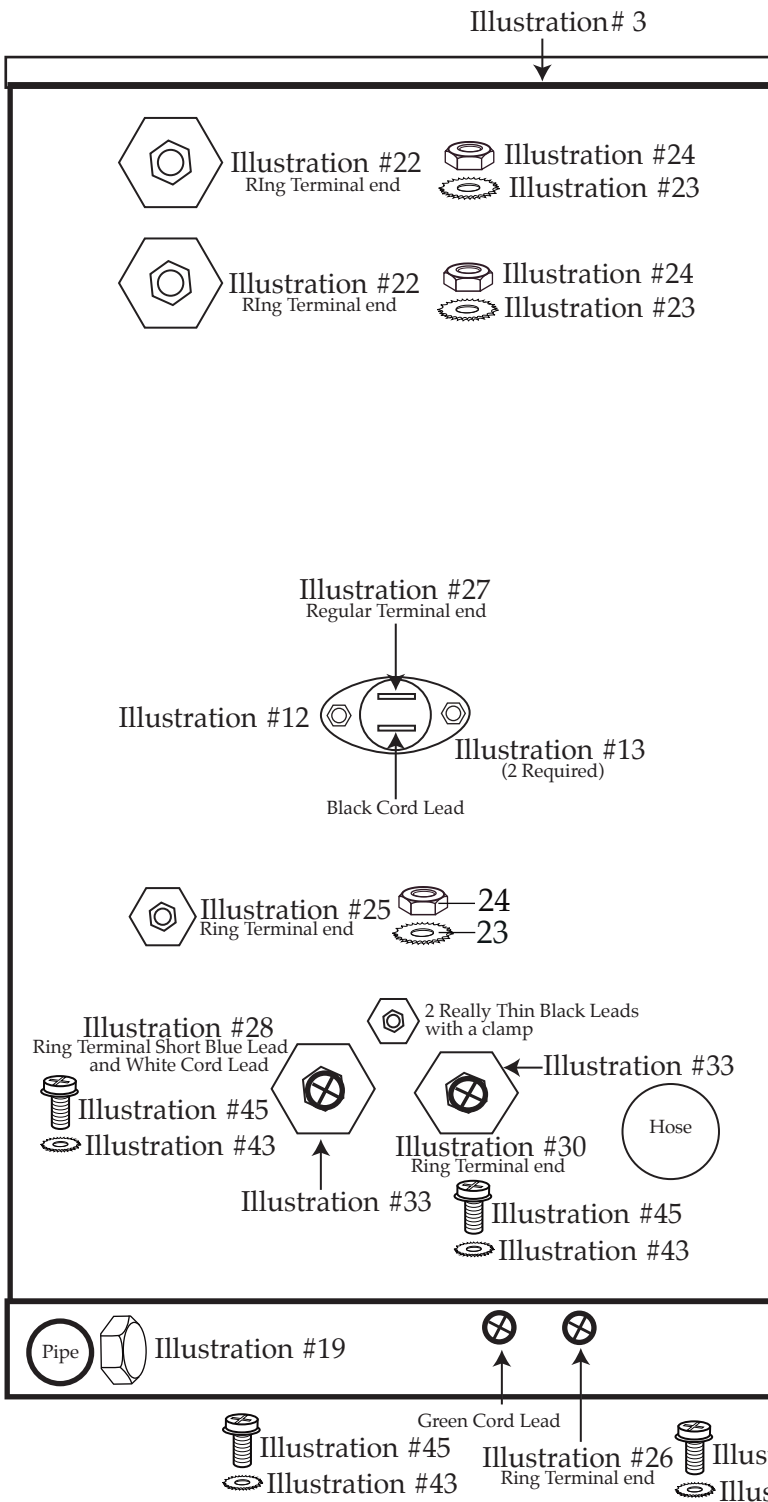

Illustration# 15

Illustration #	Part #	Description
33	037170	Element Hex Nut (2 required)
34	037172	Strain Relief
35	037173	Cord Set
36	037716	Back Plate
37	037717	Screw (8 required)
38	037720	Rubber Feet (4 required)
39	037721	Feet Screw (4 required)

# WARING COMMERCIAL

PCB Board Components  
**WWB3G**

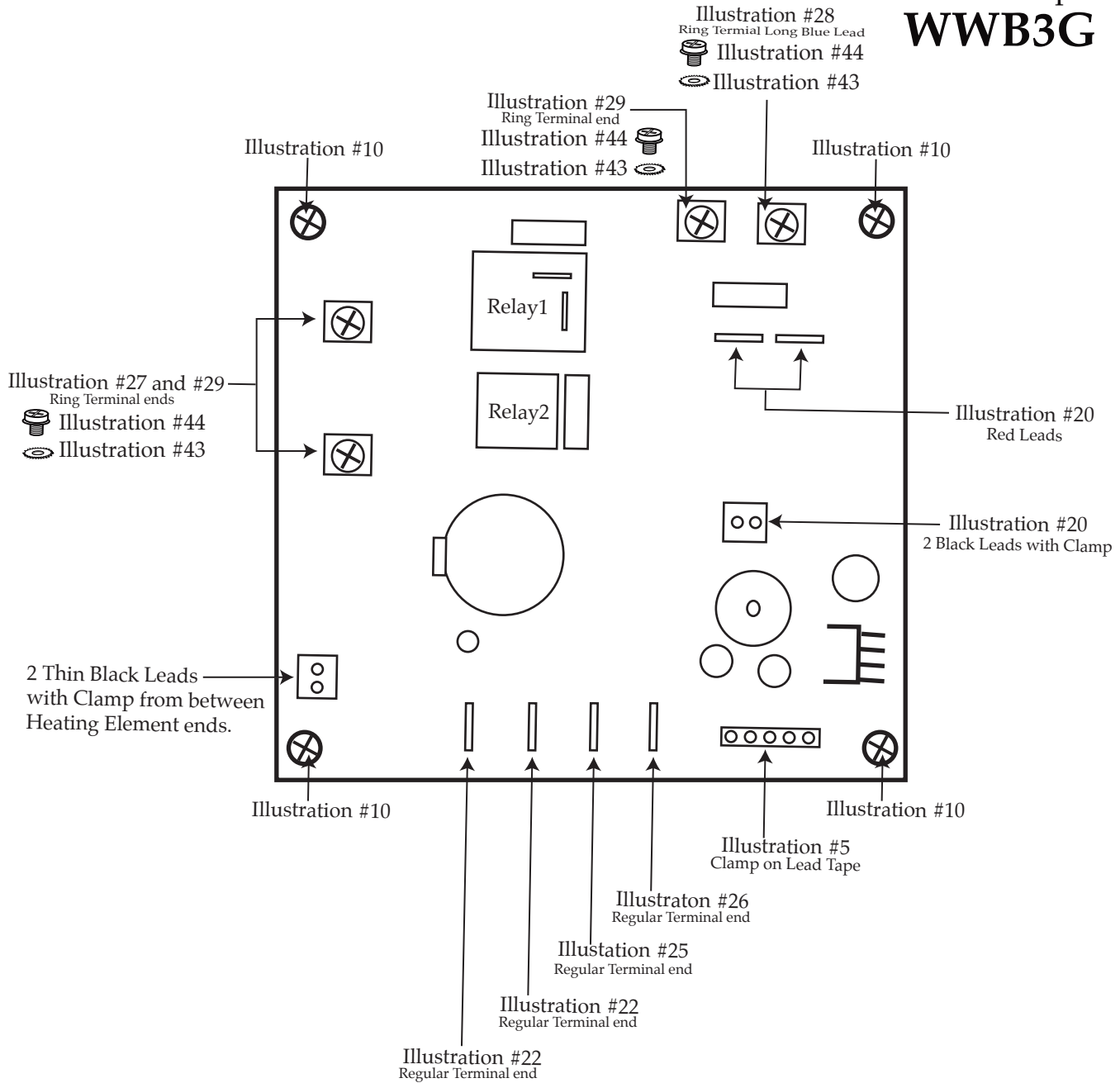

Illustration #	Part #	Description
40	037718	Bottom Plate
41	037719	Screw (6 required)
42	037717	Screw (2 required)
43	037158	Small Lock Washer
44	037701	Screw /leads to PCB board
45	037717	Screw