



WJX80

Pulp Eject Juice Extractor



Pulp Eject Juice Extractor



MAIN FEATURES

- Heavy-duty centrifugal juice extractor with continuous pulp ejection
- Built for use in smoothie shops, bars, cafés, restaurants, hotels and healthcare establishments
- Stainless steel filter basket and shredder disc expertly designed for a fantastic yield to save operators money and produce less waste
- 1.2 HP brushless induction motor
- 3,600 RPM
- Powder-coated, die-cast metal housing with stainless steel filter basket and shredder disc
- 3-inch feed chute opening can fit whole apples and hold a large capacity of fruits and vegetables
- Large, 12-quart pulp container allows for continuous operation
- Juicing spout height accommodates a 48 oz. blender jar
- Safety interlock features
- Rotating, no-drip spigot reduces mess
- Includes cleaning brush
- Limited two-year motor warranty, one year parts and labor

ELECTRICAL

Voltage: 120

Frequency: 60Hz

Watts: 1000

Amps: 8

Plug Type: NEMA 5-15P ⓘ

Cord Length: 6 feet



SALES FEATURES

Add fresh juice to your menu easily and efficiently with the Waring Commercial® Pulp Eject Juice Extractor. The brushless induction motor gives it the power to quickly and thoroughly juice fruits and vegetables for smoothies, and for making nutritious juices. Designed for continuous use, the machine is perfect for juice shops that serve juice all day. Compact size and quieter operation make this unit ideal for front-of-house usage.



@waringcommercial









©2020 Waring Commercial
314 Ella T. Grasso Avenue, Torrington, CT 06790
Tel. 800-492-7464 • Fax 860-496-9008

waringcommercialproducts.com

WJX80



PARTS & ACCESSORIES

- 
WJX80P Food Pusher
- 
WJX80LID Cover
- 
WJX80BKT Removable Filter Basket With Handles
- 
WJX80BA Bowl Attachment
- 
WJX80BWL All-Stainless Steel Juice Bowl
- 
WJX80SP Juicing Spout
- 
WJX80BIN Pulp Container
- 
WJX80CB Cleaning Brush

DIMENSIONS

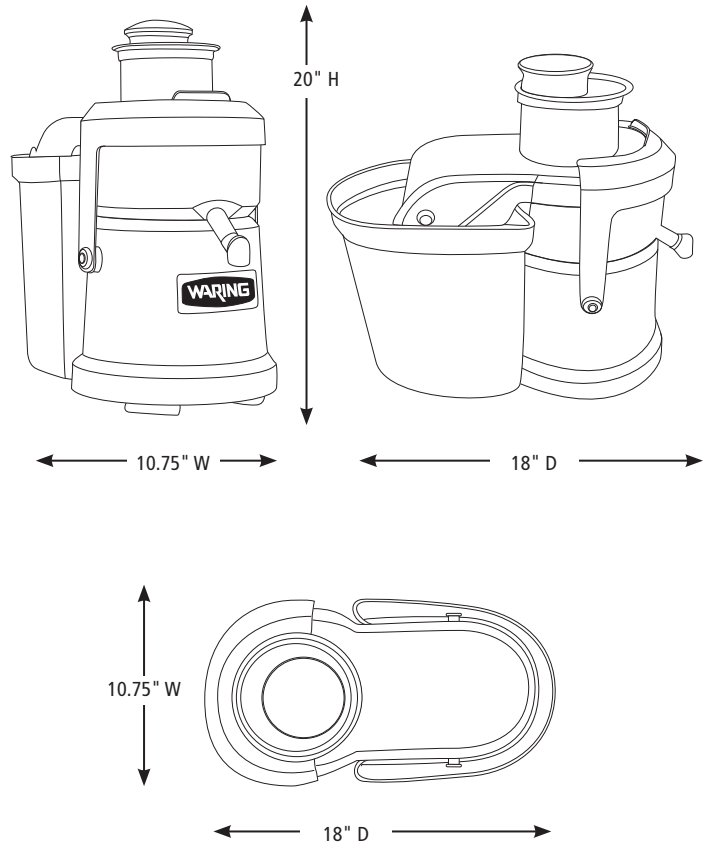

Out of Box Weight: 27 lb.

ORDERING INFORMATION	#STD. PKG.	GIFTBOX WEIGHT	CUBIC FEET	BOX DIMENSIONS D X W X H	UPC	CASE PKG.	MC WEIGHT	MC DIMENSIONS D X W X H	MBC
WJX80 – Pulp Eject Juice Extractor	1	29.3	4.3	24.625" x 14.375" x 21.125"	040072086663	1	36.6	25.125" x 14.875" x 21.75"	10040072086660



@waringcommercial

©2020 Waring Commercial
314 Ella T. Grasso Avenue, Torrington, CT 06790
Tel. 800-492-7464 • Fax 860-496-9008

waringcommercialproducts.com

19WC063818 / REV 12/19