

GRILL-MAX® GRILL-MAX® GRILL-MAX®

# GRILL-MAX<sup>®</sup> ROLLER GRILLS

MODEL  
20C, 30C, 45C, 45ST, 50C, 50ST, 75C  
54IC/ISC, 90IC/ISC  
Infinite and Electronic Controls

## Installation and Operation Instructions

2M-Z8542 Rev. H 8/04/14



30SCBB



## SAFETY SYMBOL



These symbols are intended to alert the user to the presence of important operating and maintenance instructions in the manual accompanying the appliance.

---

## RETAIN THIS MANUAL FOR FUTURE REFERENCE NOTICE

Using any part other than genuine Star factory supplied parts relieves the manufacturer of all liability.

Star reserves the right to change specifications and product design without notice. Such revisions do not entitle the buyer to corresponding changes, improvements, additions or replacements for previously purchased equipment.

Due to periodic changes in designs, methods, procedures, policies and regulations, the specifications contained in this sheet are subject to change without notice. While Star International Holdings Inc., Company exercises good faith efforts to provide information that is accurate, we are not responsible for errors or omissions in information provided or conclusions reached as a result of using the specifications. By using the information provided, the user assumes all risks in connection with such use.

## MAINTENANCE AND REPAIRS

Contact your local authorized service agent for service or required maintenance.

Please record the model number, serial number, voltage and purchase date in the area below and have it ready when you call to ensure a faster service.

Model No. \_\_\_\_\_  
Serial No. \_\_\_\_\_  
Voltage \_\_\_\_\_  
Purchase Date \_\_\_\_\_

### Authorized Service Agent Listing

Reference the listing provided with the unit

or

for an updated listing go to:

**Website:** [www.star-mfg.com](http://www.star-mfg.com)  
**E-mail** [customerservice@star-mfg.com](mailto:customerservice@star-mfg.com)

### Service Help Desk

**Business Hours:** 8:00 am to 4:30 p.m. Central Standard Time  
**Telephone:** (314) 678-6303  
**Fax:** (314) 781-2714  
**E-mail** [customerservice@star-mfg.com](mailto:customerservice@star-mfg.com)  
**Website:** [www.star-mfg.com](http://www.star-mfg.com)

**Mailing Address:** Star International Holdings Inc., Company  
10 Sunnen Drive  
St. Louis, MO 63143  
U.S.A

## TABLE OF CONTENTS

	<b>PAGE NUMBER</b>
GENERAL SAFETY INFORMATION	3
GENERAL INSTALLATION INFORMATION	4
Connection Load	4
GENERAL OPERATING INSTRUCTIONS	5
Cleaning	5
<b>ELECTRONICALLY CONTROLLED:</b>	
Start-up, Heating & Programming	6
WARRANTY	7
WIRING DIAGRAM	8-13
EXPLODED VIEW (C Series)	12, 13
<b>PARTS LIST</b>	
20 MODEL SERIES	14
30 MODEL SERIES	15, 16
45 MODEL SERIES	17, 18
50 MODEL SERIES	19, 20
75 MODEL SERIES	21, 22
EXPLODED VIEW (iC/ISC Island Series)	24
<b>PARTS LIST</b>	
54 MODEL SERIES	25, 26
30 MODEL SERIES	27, 28



### **GENERAL SAFETY INFORMATION**

This equipment is designed and sold for commercial use only by personnel trained and experienced in its operation and is not sold for consumer use in and around the home nor for use directly by the general public in food service locations.

Before using your new equipment, read and understand all the instructions & labels associated with the unit prior to putting it into operation. Make sure all people associated with its use understand the units operation & safety before they use the unit.

All shipping containers should be checked for freight damage both visible and concealed. This unit has been tested and carefully packaged to insure delivery of your unit in perfect condition. If equipment is received in damaged condition, either apparent or concealed, a claim must be made with the delivering carrier.

Concealed damage or loss - if damage or loss is not apparent until after equipment is unpacked, a request for inspection of concealed damage must be made with carrier within 15 days. Be certain to retain all contents plus external and internal packaging materials for inspection. The carrier will make an inspection and will supply necessary claim forms.

## GENERAL INSTALLATION INFORMATION

The grill should be connected to a wall type receptacle, a direct line or individual branch circuit. An individual branch circuit is preferred. If connected to an overloaded circuit the grill will not operate properly. The unit should be level when installed. Models equipped with bun boxes must be level to utilize the self-closing feature of the bun drawer. Adjustable 4-inch legs are standard on the 75 series and available for all other models.

This grill is equipped for the voltage shown on the nameplate.

It will operate on alternating current only, however, the specified voltage must be applied.

### CONNECTION LOAD:

INFINITE CONTROL		ELECTRONIC CONTROL	
MODEL SERIES	WATTAGE	MODEL SERIES	WATTAGE
20C, 20SC	930	20SCE	930
30C, 30SC, 30CF, 30SCF, 30CBB, 30CBC, 30SCBB, 30CDV	1150	30CE, 30SCE, 30SCEX, 30CBBE 30SCBBE	1150
45C, 45SC, 45CBB, 45SCBB, 45CDV	1650	45SCE, 45SCRE	1650
50C, 50SC, 50CF, 50SCF, 50CBB, 50CBC, 50SCBB, 50CDV	1535	50CE, 50SCE, 50SCEX, 50CBBE, 50SCBBE, 50CBBES	1535
54IC, 54ISC	1760	54ICE, 54ISCE	1760
75C, 75SC, 75CBB, 75SCBB, 75FF, 75SCF 208/240V	1810/2400	75CE, 75SCE, 75CBBE, 75CBBES, 75SCBBE, 75SCRE 208/240V, 75SCFE	1810/2400
75C, 75SC, 75CBB, 75SCBB, 75CDV 230V	2210	75CE, 75SCE, 75CBBE, 75SCBBE, 75SCRE 120V	1730
75C, 75CF, 75SC, 75SCF, 75CBB, 75SCBB, 75CDV 120V	1700	90ICE, 90ISCE 208V	2133
75CFV 120V	2880	90ICE, 90ISCE 240V	2840
90IC, 90ISC 208V	2133		
90IC, 90ISC 240V	2840		



**DO NOT CONNECT TO DIRECT CURRENT (DC).**

**WARNING**

**IMPORTANT**

**UNLEVEL UNITS COULD RESULT IN HAVING PRODUCT TRAVEL FROM ONE SIDE TO THE NEXT, OVER A PERIOD OF TIME.**

## GENERAL OPERATING PROCEDURES

The main switch located on the control panel controls all the power to the unit. With the main switch on, the rollers will turn, but no heat will be supplied unless the heat controls are turned on. For flexibility the heating section of the grill is divided into two individually controlled heat sections. The right control regulates the heat to the rear section and the left control regulates the heat to the front section. The switch is lighted to indicate when the unit is turned on. On Infinite control grills a signal light is provided above each heat control and indicates when the heated section is on. An additional light is provided on the end housing of the unit. This light indicates the position of the main power switch when either the optional bun drawer front or merchandising door obstructs the control panel view. Bun box equipped models require the removal of the bun drawer to remove the bun pan and to remove the drip tray when access to the rear of the unit is obstructed. To remove the bun drawer, grab the drawer by both sides and pull it out all the way. Lift the front to unhook the drawer slide from rear drawer roller. Pull the drawer the remainder of the way out. Use caution not to drop the drawer when reaching the end of the drawer slide travel. To reinsert the drawer, first hook the drawer slide over the front roller then the back roller. Do not operate the grill without the drip tray in place.

## COOKING

The heat controls provide an infinite range of settings for a wide variety of food products and installation conditions. The size, content and shape of the product and the installation of any sanitary food shields or sneeze guards will determine the proper heat setting. The National Sanitation Foundation requires that perishable foods be kept at 140°F or above during serving periods. Do not keep the food product on a low setting for more than two hours. The product should be kept refrigerated until ready for use. Cooking time will vary depending on the starting temperature and the qualities of the product. For best results when cooking hot dogs use a hot dog made for grilling.



**CAUTION**

**USE ONLY PLASTIC OR COATED UTENSILS FOR HANDLING THE FOOD PRODUCT. METAL COULD SCRATCH THE ROLLER COATING AND AFFECT THE CLEAN ABILITY OF THE ROLLERS.**



**CAUTION**

**DO NOT USE STEEL WOOL OR ABRASIVE CLEANERS ON THE ROLLERS. SCRAPES WILL VOID THE WARRANTY. USE CAUTION WHEN CLEANING A HOT GRILL TO PREVENT BURNS OR BODILY INJURY.**

## CLEANING

Before cooking for the first time, wash the rollers with mild soap and water using a soft cloth. Do not use metal utensils when cooking. Scratches and scrapes will hamper the ability to easily clean the rollers. Never use steel wool or abrasive cleaners on the rollers. This will damage the finish and the roller bearings. The rollers clean most easily when hot. Use caution when cleaning to prevent burns and bodily injury. Clean the rollers with a clean wet cloth. Wipe from the ends to the center to prevent forcing debris into the roller seals. Do not allow the food product to build up and bake onto the roller surface. The exterior of the unit should be cleaned using a mild detergent or non-abrasive cleaner. Clean the entire unit daily to insure long life and satisfactory performance as well as to maintain an attractive appearance. Do not clean with water jet equipment.

## MAINTENANCE AND REPAIRS

Contact the factory, a service representative or a local service company for service or required maintenance. Replacement cord sets must be purchased from Star Manufacturing International, Inc.

# OPERATING PROCEDURES FOR ELECTRONIC GRILLS

## START-UP

When initially turning on power to the electronic controlled grill, it will be in the HOLD mode. The displays will flash until the setpoint temperature is reached. The grill will beep once when it is up to temperature. Infinite controlled grills have no notification when operating temperature is reached.

## HEATING

The size, content, and shape of the product and the installation of any sanitary food shields or sneeze guards will determine the proper heat setting. The National Sanitation Foundation requires that all perishable foods be kept at 140°F or above during serving periods.

The product should be kept refrigerated until ready to use. Heating times vary depending on the starting temperature and the qualities of the product. For best results, use a hot dog made for grilling.

Before cooking for the first time, wash the rollers with mild soap and water using a soft cloth. When the electronic controlled grills are initially turned on, the displays will flash the HOLD temperature until the grill reaches that setpoint.







With the grill preheated to the hold temperature, load with the desired product and press the HEAT button. The grill will then go into the heat mode and the displays will flash until the HEAT temperature is reached. After the heating cycle, the grill will beep four times and the food product will be at the serving temperature.

**NOTE:** Based on the product being heated, some experimentation is required to find the optimal HEAT temperature and HEAT time to bring the product up to temperature in an acceptable amount of time.

## PROGRAMMING

The electronic controls provide programmable HEAT and HOLD settings for a variety of food products and installation conditions.

To program the electronic roller grill:

1. With the grill on, push and hold the  and  on the side you wish to program together for three seconds until the alarm beeps once and the display blanks.
2. To set the heat temperature and/or heat time, push the heat button. The last saved heat time will be displayed and the HEAT LED will flash and HEAT TIME indicator will be ON. Use the  and  buttons to adjust to the desired time, then press the HEAT button again. The HEAT TIME LED indicator will turn off and the HEAT TEMP LED indicator will now be lit. When programming the HEAT temperature is complete, push the HEAT button one more time to exit the programming mode.
3. To set the hold temperature, repeat step 1 above then push the HOLD button. The last saved hold temperature will be displayed and HOLD LED will be ON. Use the  and  buttons to adjust to the desired temperature, then press the HOLD button again to exit programming mode.
4. To turn the heat off to the front or rear section, press and hold the  for that section for 3 seconds. "OFF" will be displayed. To turn the section back on, press the HEAT or HOLD button.

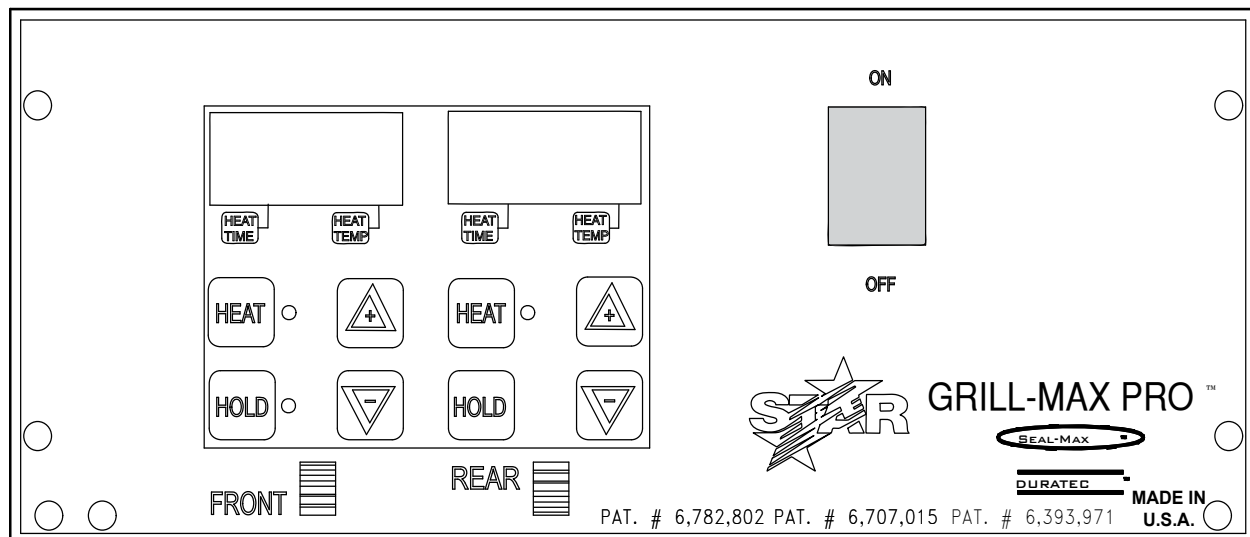

Electronic Control Board

### THOROUGHLY INSPECT YOUR UNIT ON ARRIVAL

This unit has been tested for proper operation before leaving our plant to insure delivery of your unit in perfect condition. However, there are instances in which the unit may be damaged in transit. In the event you discover any type of damage to your product upon receipt, you must immediately contact the transportation company who delivered the item to you and initiate your claim with same. If this procedure is not followed, it may affect the warranty status of the unit.

### LIMITED EQUIPMENT WARRANTY

All workmanship and material in Star products have a one (1) year limited warranty on parts & labor in the United States and Canada. Such warranty is limited to the original purchaser only and shall be effective from the date the equipment is placed in service. Star's obligation under this warranty is limited to the repair of defects without charge, by the factory authorized service agency or one of its sub-agencies. Models that are considered portable (*see below*) should be taken to the closest Star service agency, transportation prepaid.

- > Star will not assume any responsibility for loss of revenue.
- > On all shipments outside the United States and Canada, see International Warranty.
- \* The warranty period for the Ultra-Max, Hot Plates, Griddles, Charbroilers is (3) years parts & labor.
- \* The warranty period for the Star-Max, Charbroilers, Griddles, Hot Plates, Fryers & Finishing Oven is (2) years parts & labor.
- \* The warranty period for the JetStar six (6) ounce & Super JetStar eight (8) ounce series popcorn machines is two (2) years.
- \* The warranty period for the Chrome-Max Griddles is five (5) years on the griddle surface. See detailed warranty provided with unit.
- \* The warranty period for Dura-Tec coatings is one year under normal use and reasonable care. This warranty does not apply if damage occurs to Dura-Tec coatings from improper cleaning, maintenance, use of metallic utensils, or abrasive cleaners, abrasive pads, product identifiers and point-of-sale attachments, or any other non-food object that comes in continuous contact with the roller coating. This warranty does not apply to the "non-stick" properties of such materials.
- > This warranty does not apply to "Special Products" but to regular catalog items only. Star's warranty on "Special Products" is six (6) months on parts and ninety (90) days on labor.
- > This warranty does not apply to any item that is disassembled or tampered with for any purpose other than repair by a Star Authorized Service Center or the Service Center's sub-agency.
- > This warranty does not apply if damage occurs from improper installation, misuse, wrong voltage, wrong gas or operated contrary to the Installation and Operating instructions.
- > This warranty is not valid on Conveyor Ovens *unless* a "start-up/check-out" has been performed by a Factory Authorized Technician.

### PARTS WARRANTY

Parts that are sold to repair out of warranty equipment are warranted for ninety (90) days. The part only is warranted, the labor to replace the part is **NOT** warranted.

### SERVICES NOT COVERED BY WARRANTY

1. Travel time and mileage rendered beyond the 50 mile radius limit
2. Mileage and travel time on portable equipment (*see below*)
3. Labor to replace such items that can be replaced easily during a daily cleaning routine, ie; removable kettles on fryers, knobs, grease drawers on griddles, etc.
4. Installation of equipment
5. Damages due to improper installation
6. Damages from abuse or misuse
7. Operated contrary to the Operating and Installation Instructions
8. Cleaning of equipment
9. Seasoning of griddle plates
10. Voltage conversions
11. Gas conversions
12. Pilot light adjustment
13. Miscellaneous adjustments
14. Thermostat calibration and by-pass adjustment
15. Resetting of circuit breakers or safety controls or reset buttons
16. Replacement of bulbs
17. Replacement of fuses
18. Repair of damage created during transit, delivery, & installation OR created by acts of God

### PORTABLE EQUIPMENT

Star will not honor service bills that include travel time and mileage charges for servicing any products considered "Portable" including items listed below. These products should be taken to the Service Agency for repair:

- \* The Model 510FD, 510FF Fryer.
- \* The Model 526TOA Toaster Oven.
- \* The Model J4R, 4 oz. Popcorn Machine.
- \* The Model 518CMA & 526CMA Cheese Melter.
- \* The Model 12MC & 15MC & 18MCP Hot Food Merchandisers.
- \* The Model 12NCPW & 15NCPW Nacho Chip/Popcorn Warmer.
- \* All Hot Dog Equipment **except Roller Grills & Drawer Bun Warmers.**
- \* All Nacho Cheese Warmers **except Model 11WLA Series Nacho Cheese Warmer.**
- \* All Condiment Dispensers **except the Model HPD & SPD Series Dispenser.**
- \* All Specialty Food Warmers **except Model 130R, 11RW Series, and 11WSA Series.**
- \* All QCS/RCS Series Toasters **except Model QCS3 & RCS3 Series.**
- \* All Fast Steamer Models **except Direct Connect Series.**

### ALL:

- \* Pop-Up Toasters
- \* Butter Dispensers
- \* Pretzel Merchandisers  
(Model 16PD-A Only)
- \* Pastry Display Cabinets
- \* Nacho Chip Merchandisers
- \* Accessories of any kind
- \* Sneeze Guards
- \* Pizza Ovens  
(Model PO12 Only)
- \* Heat Lamps
- \* Pumps-Manual

The foregoing warranty is in lieu of any and all other warranties expressed or implied and constitutes the entire warranty.

### FOR ASSISTANCE

Should you need any assistance regarding the Operation or Maintenance of any Star equipment; write, phone, fax or email our Service Department. In all correspondence mention the Model number and the Serial number of your unit, and the voltage or type of gas you are using.

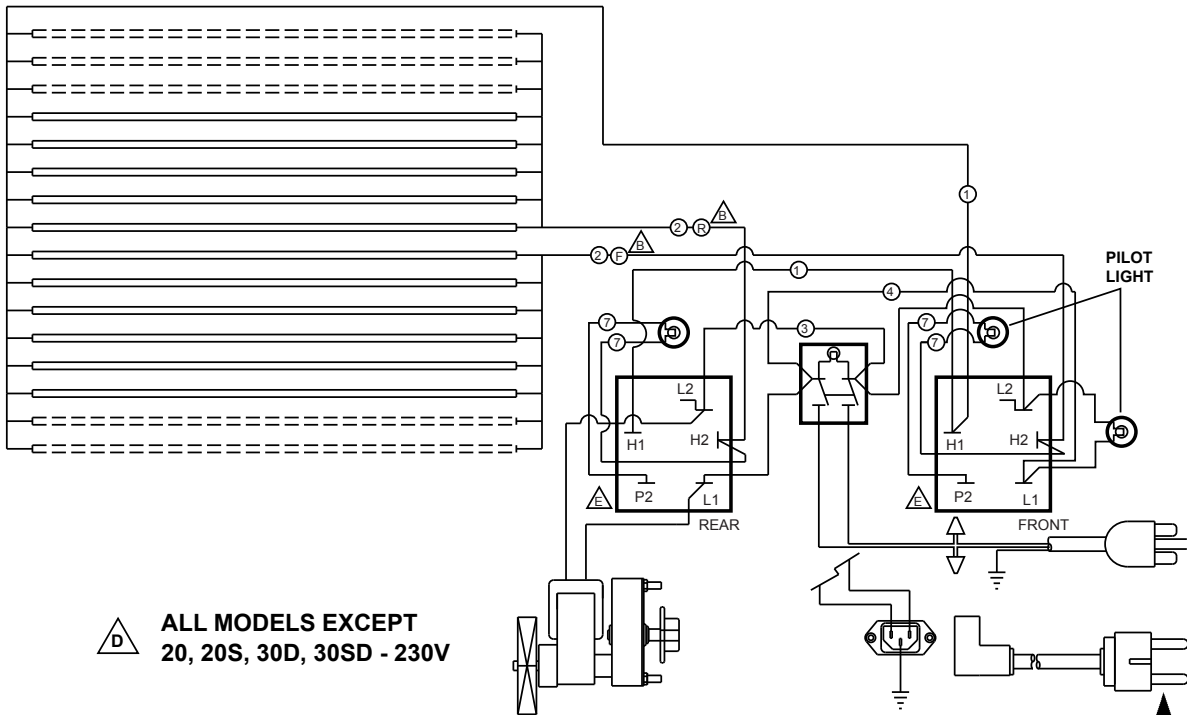

(AS VIEWED FROM REAR OF PANEL)



**MODEL: RG SERIES, INFINITE CONTROLS**

THIS DRAWING CONTAINS INFORMATION CONFIDENTIAL TO STAR MFG. INT'L. INC.  
NO REPRODUCTION OR DISCLOSURE OF ITS CONTENTS IS PERMITTED.

**STAR MANUFACTURING INTERNATIONAL INC.**

SK1646

Rev E

1/13/2011

STAR MANUFACTURING INTERNATIONAL INC. #10 SUNNEN DRIVE, ST. LOUIS, MO. 63143, USA			MATERIAL		MODEL NO.	PART NO.						
			FINISH		RG SERIES	SK1663						
DR.	BN	CK.	DATE	TITLE								
			6/16/00	WIRE DIAGRAM								
TOLERANCES UNLESS OTHERWISE NOTED FRACTIONS ± 1/64 DECIMALS ± .005				THIS DRAWING CONTAINS INFORMATION CONFIDENTIAL TO STAR MFG. INT'L. INC. NO REPRODUCTION OR DISCLOSURE OF ITS CONTENTS IS PERMITTED.				REVISIONS	LTR	DATE	DESCRIPTION OF CHANGE	DR
								B		6/16/00	REDRAWN TO NEW STAR TITLE REDRAWN FOR CLARITY	BN
								C		1/4/2010	UPDATE WIRE CALLOUTS	MCT
								D		1/13/2010	UPDATE PILOT LIGHTS AND INFINITE CONTROL	MCT
<p>(AS VIEWED FROM REAR OF PANEL)</p> <p>MODEL 30D &amp; 30SD 230 VOLT</p>						<p>(AS VIEWED FROM REAR OF PANEL)</p> <p>MODEL 20 &amp; 20S 230 VOLT</p>						





STAR MANUFACTURING INTERNATIONAL INC.  
#10 SUNNEN DRIVE, ST. LOUIS, MO. 63143, USA

MATERIAL	-
FINISH	-

MODEL NO.	75AFV
TITLE	WIRING DIAGRAM 75AFV-120V
REVISIONS	LTR DATE DESCRIPTION OF CHANGE DR
	A 1/13/11 UPDATE PILOT LIGHTS AND INFINITE CONTROL MCT

PART NO.	SK1917
----------	--------

DR.	CK.	DATE
DWD		11/12/02

TOLERANCES UNLESS OTHERWISE NOTED  
FRACTIONS ±1/64 DECIMALS ±.005 ANGLES ±1°

THIS DRAWING CONTAINS INFORMATION CONFIDENTIAL TO STAR MFG. INT'L. INC.  
NO REPRODUCTION OR DISCLOSURE OF ITS CONTENTS IS PERMITTED.

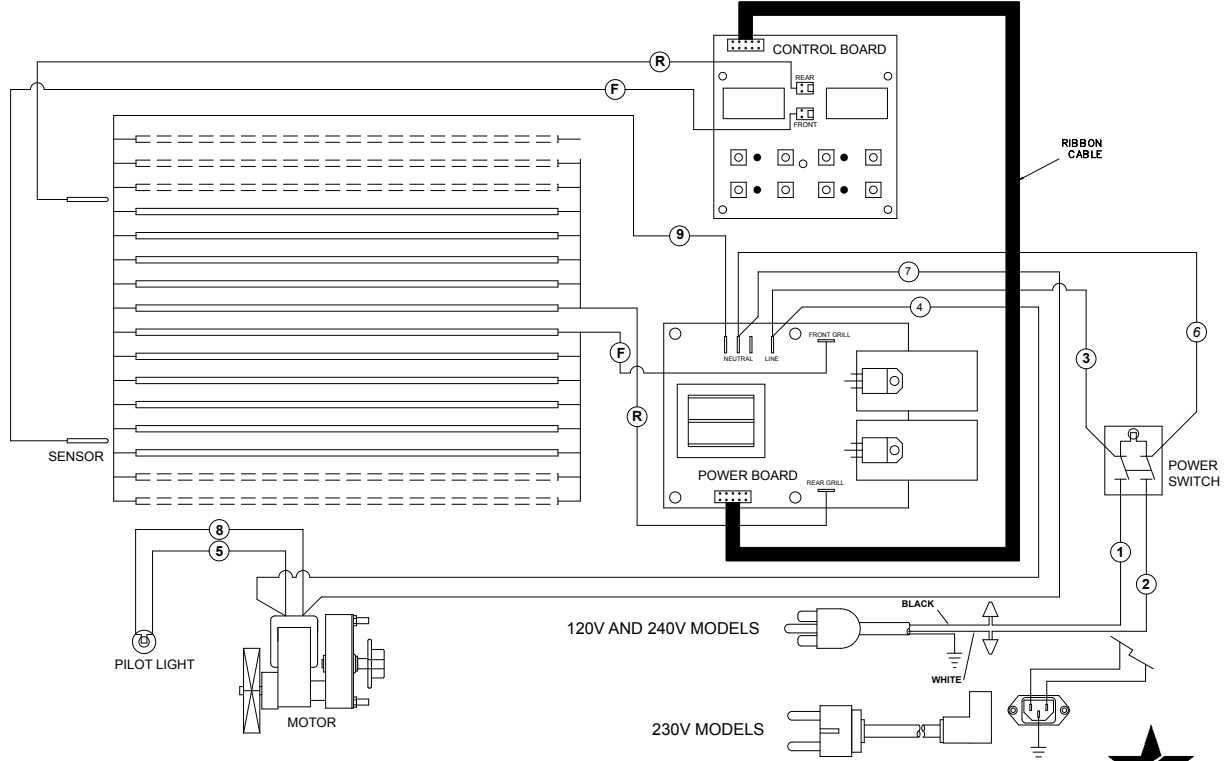
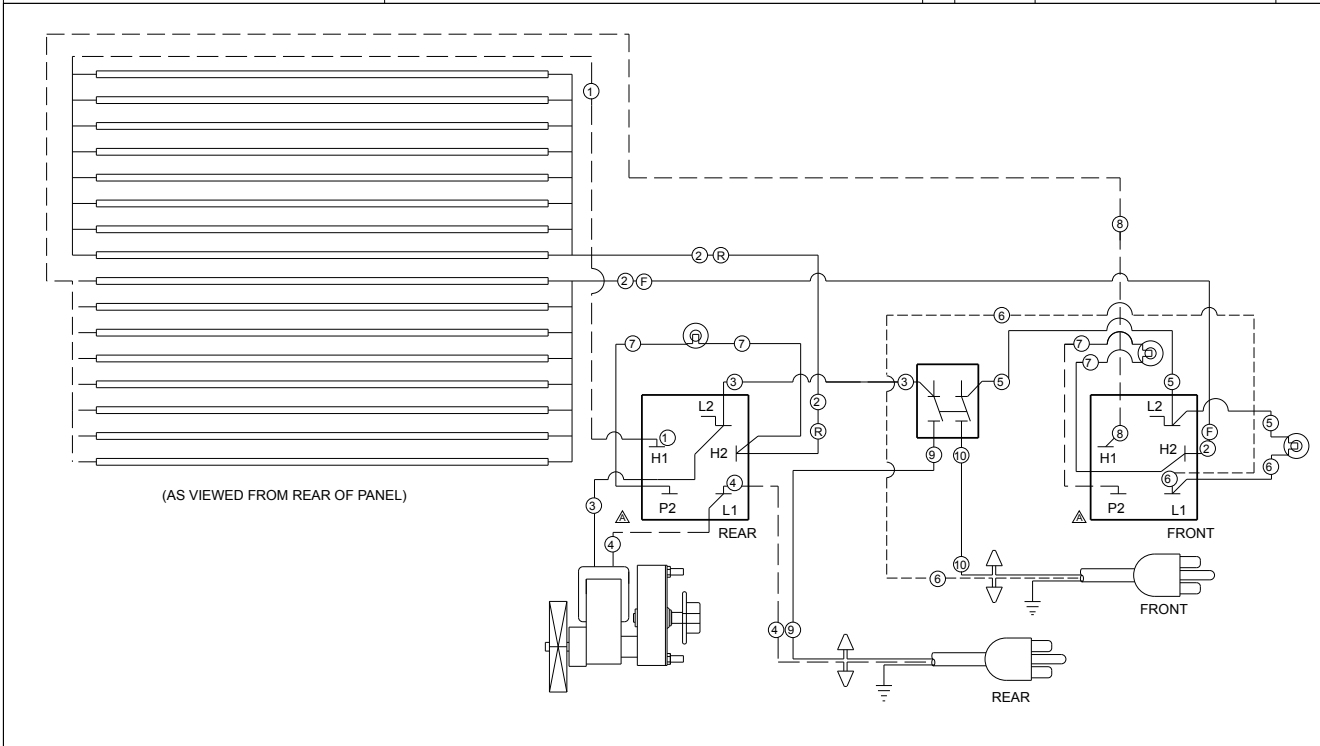

**MODEL: RGE SERIES,  
ELECTRONIC CONTROLS**

THIS DRAWING CONTAINS INFORMATION CONFIDENTIAL TO STAR MFG. INT'L. INC.  
NO REPRODUCTION OR DISCLOSURE OF ITS CONTENTS IS PERMITTED.

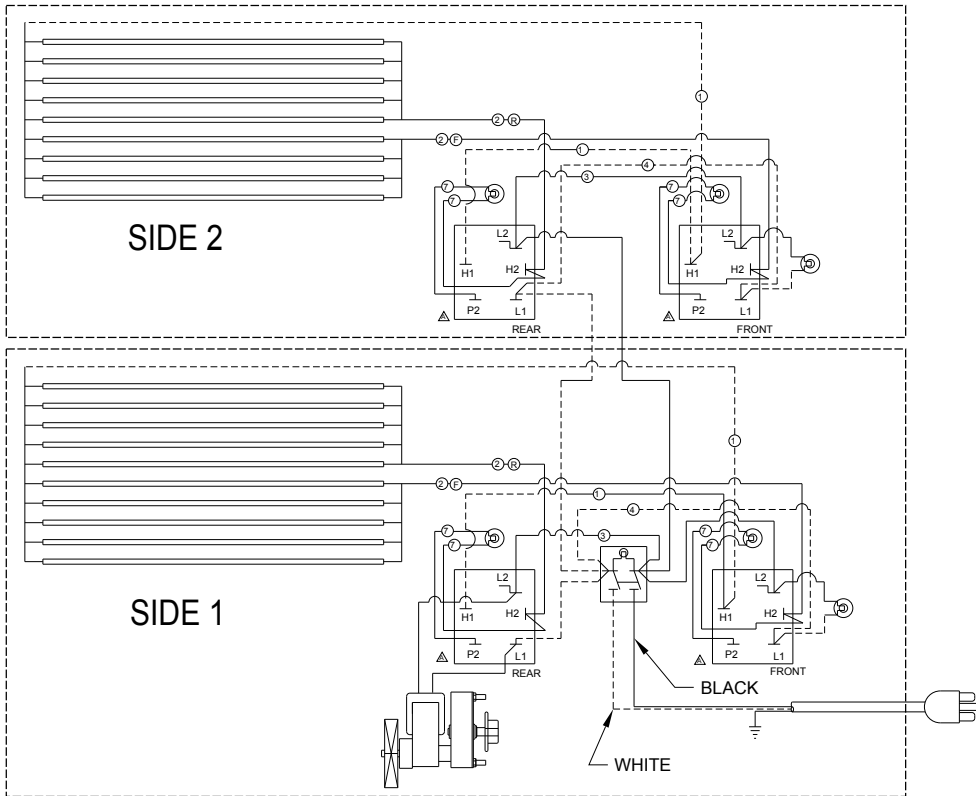

**MODEL: IC/ISC ISLAND INFINITE CONTROL**

THIS DRAWING CONTAINS INFORMATION CONFIDENTIAL TO STAR MFG. INT'L. INC.  
NO REPRODUCTION OR DISCLOSURE OF ITS CONTENTS IS PERMITTED.

**STAR MANUFACTURING INTERNATIONAL INC.**

SK2132

Rev. A

1/14/2011

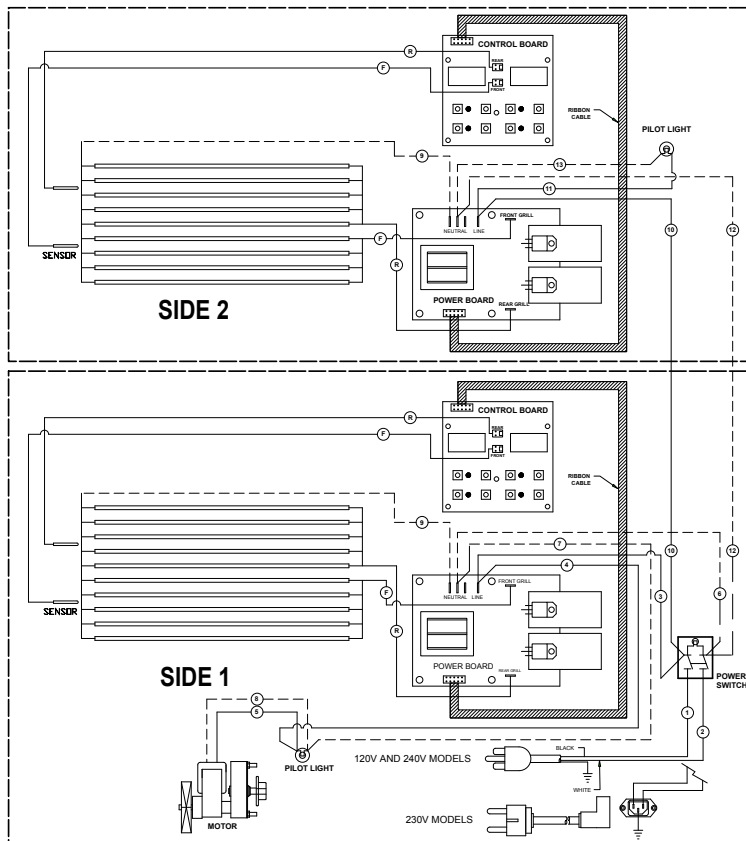

**MODEL: ICE/ISCE ISLAND ELECTRONIC CONTROL**

THIS DRAWING CONTAINS INFORMATION CONFIDENTIAL TO STAR MFG. INT'L. INC.  
NO REPRODUCTION OR DISCLOSURE OF ITS CONTENTS IS PERMITTED.

**STAR MANUFACTURING INTERNATIONAL INC.**

SK2197

Rev. -

5/24/2006



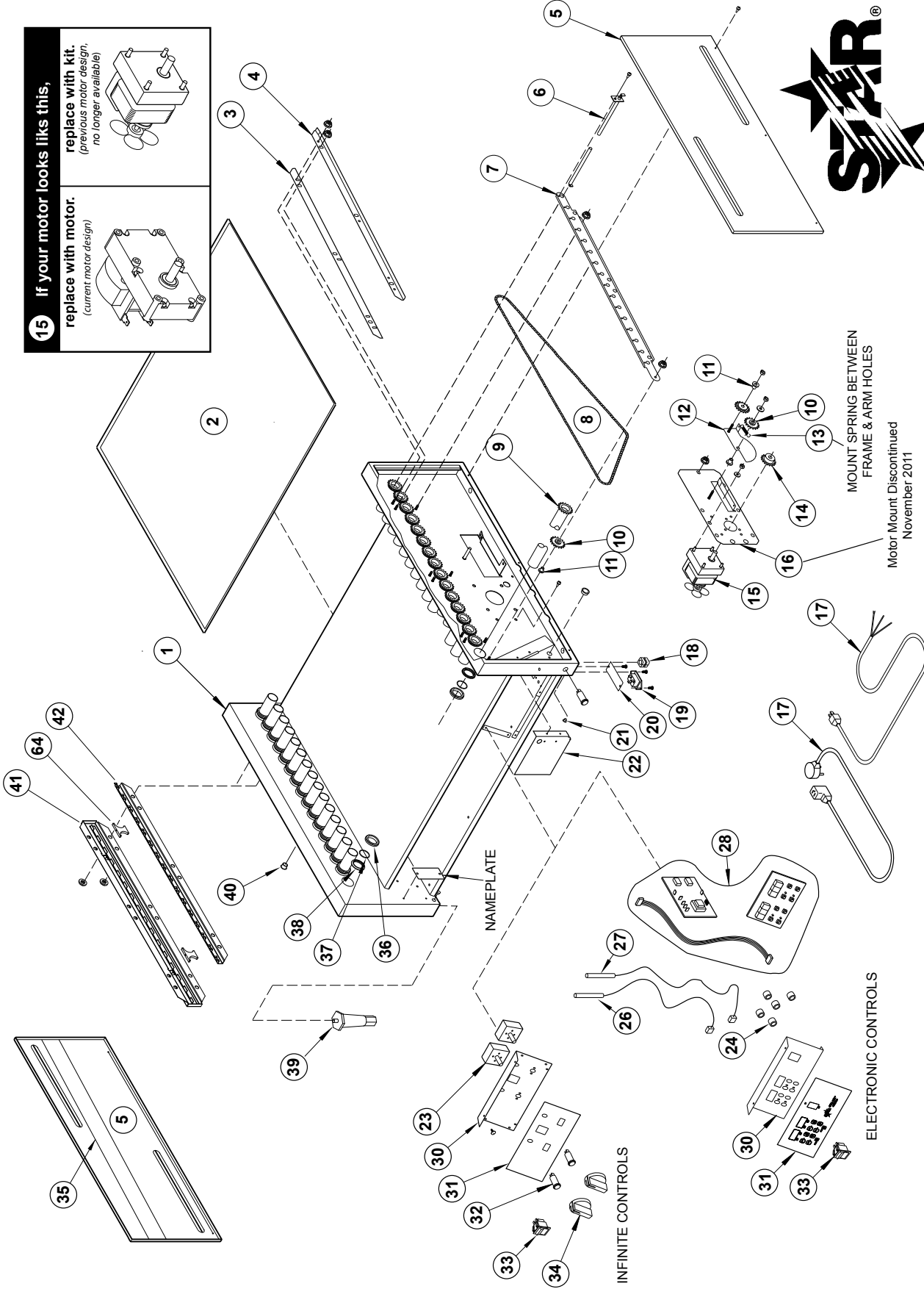

**15** If your motor looks like this, replace with motor. (current motor design)

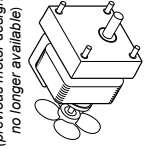

replace with kit. (previous motor design, no longer available)

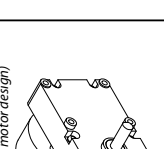

REFER TO THE PARTS LIST SPECIFIC TO YOUR MODEL FOR MORE DETAIL INFORMATION.

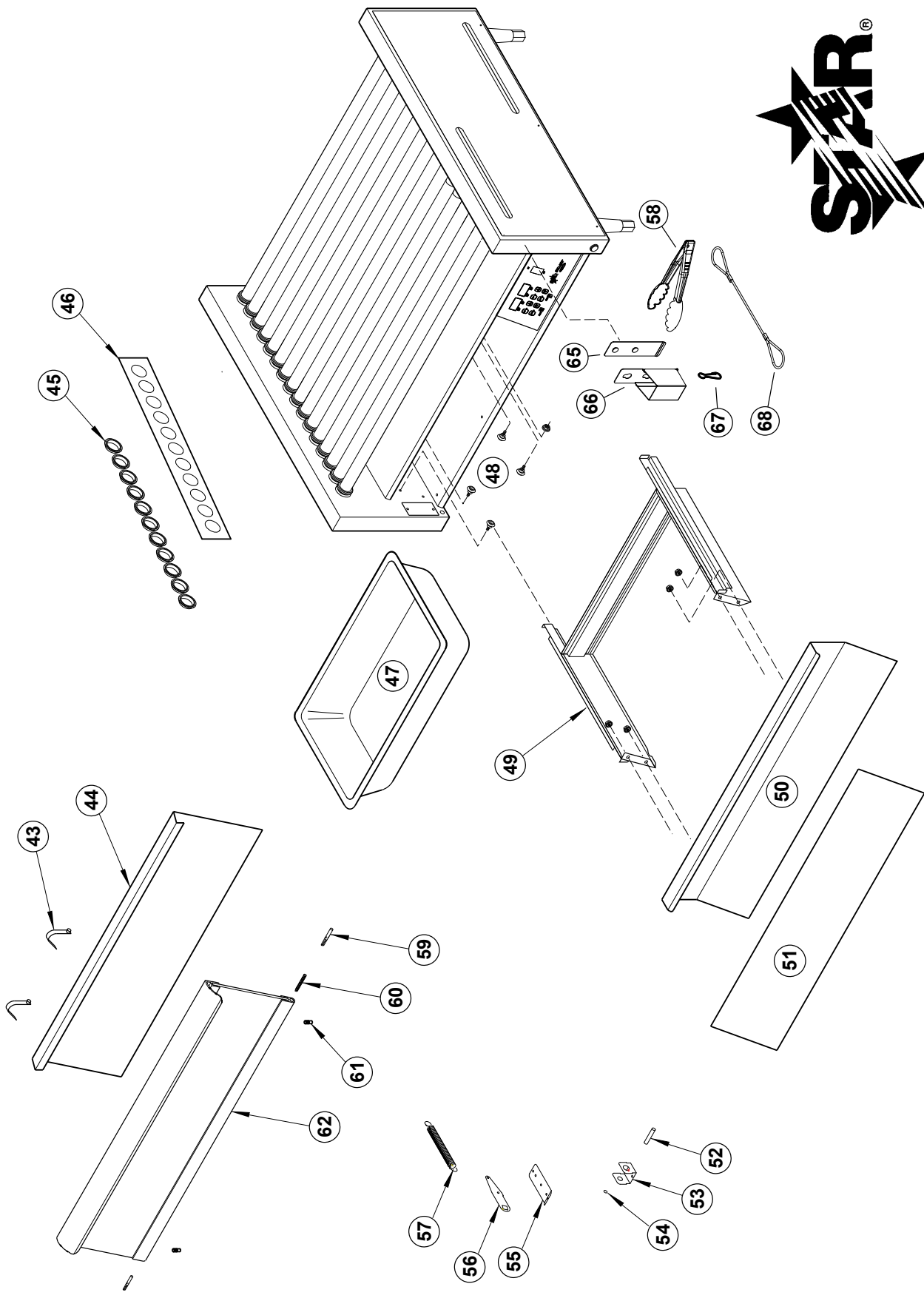

STAR MANUFACTURING INTERNATIONAL INC.  
 SK2110 REV. B 3-17-15

REFER TO THE PARTS LIST SPECIFIC TO  
 YOUR MODEL FOR MORE DETAIL INFORMATION.

# PARTS LIST

August 04, 2014, Rev. H

Model: Grill-Max Roller Grills 20 Series				
Fig No	Part No	Qty	Description	Application
1	A5-RG2028	1	BODY ASSY	20CR/SCR
	A5-RG2027			20C/SC
2	A5-Z2184	1	DRIP TRAY	20C/SC
3	A5-Z8409	1	BACK-CHAIN RETAINER SPACER	20C/SC
4	A5-Z8410	1	ANGLE CHAIN RETAINER UPPER	20C/SC
5	A5-Z2169	2	SIDE PANEL	20C/SC
6	2N-Z2181	11	ELEMENT 120V 20	20C-120V
	2N-Z2611		ELEMENT 230V 20	20C-230V
7	A5-Z6719	1	CHAIN GUIDE	20C/SC
8	2P-Z2242	1	CHAIN	20C/SC
9	PS-RG2029	11	ROLLER ASSY CHROME	20C
	PS-RG2030		ROLLER ASSY POLY	20SC
	PS-RG2049		ROLLER ASSY HI-GRIP	20SC
10	2P-Z8392	3	IDLER SPROCKET	ALL
11	2A-Z8017	3	BUSHING, IDLER	ALL
12	A5-RG30121	1	IDLER ARM ASSY-CHAIN TENS	ALL
13	2P-Z8074	1	SPRING	ALL
14	2P-Z8317	1	MOTOR SPROCKET	ALL 3/8" MOTOR SHAFTS
	2P-Z11853			ALL 1/2" MOTOR SHAFTS
15	2U-Z11854	1	MOTOR GEAR, 120V	120V, w/ 1/2" DIA SHAFT
	PS-RG5069		KIT MOTOR, SPROCKET-120 VOLT	120V, w/SPROCKET & MNT PLATE
	2U-Z11855		MOTOR GEAR, 240V	230/240V, w/ 1/2" DIA SHAFT
	PS-RG5070		KIT MOTOR, TENSION-230/240V	230/240V, w/SPROCKET & MNT PLATE
16	A5-RG2046	1	MOTOR MOUNTING ASSY	20C/SC
17	A5-RG2036	1	CORD ASSY 120V	20C/SC (120V MODELS EXCEPT CSA)
	2E-Z0512		CORD SET EUR 10AMP	20C/SC (230V MODELS)
18	2K-Y2968	1	CORD BUSHING	20C/SC 120V
	2K-Y3240			20C/SC 240V
19	2E-Y9227	1	CORD INLET IEC320 10 AMP	20C/SC (230V MODELS)
20	A5-Z5335	1	BOTTOM COVER PLATE	ALL
22	A5-Z9344	1	MOUNTING BRACKET	20C/SC
23	PS-RG5095	2	KIT, CONTROL 230/240 VOLT	20C/SC
	PS-RG5094		KIT, CONTROL 120 VOLT	20C/SC
24	2K-Z1971	9	SPACERS	20SCE
26	PS-RG50132	1	KIT, SERVICE FNT PROBE REPL	20SCE, mfg before 7/2014
	2J-Z17919		THERMISTOR, FRONT .125" DIA	20SCE, mfg after 6/2014
27	2J-Z15324	1	THERMISTOR, REAR .125X1.00 LG	20SCE,
28	PS-RG5087	1	KIT POWER BOARD	20SCE
30	A5-Z7853	1	CONTROL PANEL	20C/SC
	A5-RG2047		CONTROL PANEL	20SCE
31	2M-Z8323	1	CONTROL PANEL LABEL	20C
	2M-Z8324			20SC
	2M-Z9529			20SCE
32	2J-Z2329	3	PILOT LIGHT RED	20C/SC (120V & 240V MODELS)
	2J-Z3157		PILOT LIGHT YELLOW	20C/SC (230V MODELS)
33	2E-Z1858	1	SWITCH-RED LIGHTED	120V & 240V MODELS
	2E-Z3156		SWITCH-YELLOW LIGHTED	230V MODELS
34	2R-Z1854	2	KNOB W/SET SCREW	20C/SC
35	A5-Z2509	4	PANEL-INSULATOR	20C/SC
36	2I-Z9865	22	O-RING SILICONE, TUBE SEAL	20C/SC, manuf. after 8/07
	2P-Z6455		TUBE SEAL, SOLID	20C/SC, manuf. before 8/07
37	2I-Z2175	22	O-RING SEAL	20C/SC
38	2P-Z2174	22	TUBE GUIDE	20C/SC
39	2R-Z5846	4	LEGS	20C/SC
40	2K-Z2895	4	ANTI SHORT BUSHING	ALL
41	A5-Z7650	1	ELEMENT RETAINER - UPPER	20C/SC
	A5-Z17589		ELEMENT MOUNT UPPER	20SCE
42	A5-Z7656	1	ELEMENT RETAINER - LOWER	20C/SC
	A5-RG50107		ASSY, ELEM THERMISTOR MT 11CT	20SCE
43	2P-Y9176	2	SNAP BUTTON	Goes with No 44
44	8A-20RGMD	optional	MERCHANDISING DOOR	OPTIONAL ASSESSORY
58	A5-Z6424	1	TONGS	ALL
64	2V-Z17584	2	THERMAL, BLOCK	20SCE
NI	2E-Z3619	1	WIRE SET-230V MODELS	
NI	2E-Z8320	1	WIRE SET-120V MODELS	20C/SC
NI	PS-Z3018	--	TUBE ASSEMBLY SLEEVE	

2M-Z8542: Grill-Max Rollergill, Star Manufacturing International

# PARTS LIST

August 04, 2014, Rev. H

Model: Grill-Max Roller Grills 30 Series				
Fig No	Part No	Qty	Description	Application
1	A5-RG3062	1	BODY ASSY	30C/SC/STE
	A5-RG3070			30CBB/SCBB
	A5-RG3087			30CBBC/SCBBC
	A5-RG3068			30CF/SCF
	A5-RG3066			30CR/SCR
	A5-RG3072			30CRBB/SCRBB
2	A5-Z2185	1	DRIP TRAY	30C/SC
3	A5-Z8409	1	BACK-CHAIN RETAINER SPACER	30C/SC
4	A5-Z8410	1	ANGLE CHAIN RETAINER UPPER	30C/SC
5	A5-Z2169	2	SIDE PANEL	30C/SC
	A5-Z5401			30CF/SCF
6	2N-Z2178	11	ELEMENT 120V 30/45	30C/SC/STE-120V
	2N-Z2194		ELEMENT 230V 30/45	30C/SC-230V
7	A5-Z6719	1	CHAIN GUIDE	30C/SC
8	2P-Z2242	1	CHAIN	30C/SC
	2P-Z5384			30CF/SCF
9	PS-RG3077	11	ROLLER ASSY CHROME	30C
	PS-RG3078		ROLLER ASSY POLY	30SC before serial no. C3004650 30SCE before serial no. C3004265
	A5-RG4565		ROLLER ASSY HI-GRIP	30SC serial no or after. C3004650 30SCE serial no or after. C3004650
	A5-RG30166		RLR ASY STALTEK 30ST/45ST	30STE
10	2P-Z8392	3	IDLER SPROCKET	ALL
11	2A-Z8017	3	BUSHING, IDLER	ALL
12	A5-RG30121	1	IDLER ARM ASSY-CHAIN TENS	ALL
13	2P-Z8074	1	SPRING	ALL
14	2P-Z8317	1	MOTOR SPROCKET	ALL 3/8" MOTOR SHAFTS
	2P-Z11853			ALL 1/2" MOTOR SHAFTS
15	2U-Z11854	1	MOTOR GEAR, 120V	120V, w/ 1/2" DIA SHAFT
	PS-RG5069		KIT, MOTOR, 120V	120V, w/SPROCKET & MNT PLATE
	PS-RG5072		KIT, MOTOR, -120V FLAT	120V, FLAT w/SPROCKET & MNT PLATE
	2U-Z11855		MOTOR GEAR, 240V	230/240V, UNITS w/ 1/2" DIA SHAFT
	PS-RG5070		KIT, MOTOR, -230/240V	230/240V, UNITS w/SPROCKET & MNT PLATE
	PS-RG5073		KIT, MOTOR, -230/240V FLAT	230/240V, FLAT UNITS w/SPROCKET & MNT PLATE
16	A5-RG2063	1	MOTOR MOUNTING ASSY	30C/SC/STE
	A5-RG5071			30CF/SCF
17	A5-RG2036	1	CORD ASSY 120V	30C/SC/STE (120V MODELS EXCEPT CSA)
	2E-Z0512		CORD SET EUR 10AMP	30C/SC (230V MODELS)
18	2K-Y3240	1	CORD BUSHING	30C/SC 240V
	2K-Y2968			30C/SC/STE 120V, 30CSA
19	2E-Y9227	1	CORD INLET IEC320 10 AMP	30C/SC (230V MODELS)
20	A5-Z5335	1	BOTTOM COVER PLATE	ALL
21	2P-Z1540	2	HOLE PLUG	ALL EXCEPT CLEAR BUNBOX MODELS
22	A5-Z9344	1	MOUNTING BRACKET	30C/SC
	A5-RG4554		MOUNTING BRACKET ASSY	30CE/SCE/STE
23	PS-RG5095	2	KIT, CONTROL 230/240 VOLT	30C/SC
	PS-RG5094		KIT, CONTROL 120 VOLT	30C/SC
24	2K-Z1971	9	SPACERS	30CE/SCE
26	PS-RG50132	1	KIT, SERVICE FNT PROBE REPL	30CE/SCE, mfg before 7/2014
	2J-Z17919		THERMISTOR, FRONT .125" DIA	30CE/SCE/STE, mfg after 6/2014
27	2J-Z15324	1	THERMISTOR, REAR .125X1.00 LG	30CE/SCE
28	PS-RG5087	1	KIT, CONTROL, ELECTRONIC	30CE/SCE, mfg before 11/2010
	2E-Z13638		ELECTRONIC CONTROL RG	30CE/SCE/STE, mfg after 11/2010
30	A5-Z7651	1	CONTROL PANEL	30C/SC
	A5-Z7753			30CBB/SCBB
	A5-RG3069			30CE/SCE/STE
	A5-RG3071			30CBBE/SCBBE

# PARTS LIST

August 04, 2014, Rev. H

Model: Grill-Max Roller Grills 30 Series				
Fig No	Part No	Qty	Description	Application
31	2M-Z8325	1	CONTROL PANEL LABEL	30C
	2M-Z8326			30CBB
	2M-Z8328			30CBBE
	2M-Z8327			30CE
	2M-Z8329			30SC
	2M-Z8330			30SCBB
	2M-Z8331			30SCBBE
	2M-Z8332			30SCE/STE
32	2J-Z2329	3	PILOT LIGHT RED	30C/SC (120V & 240V MODELS)
	2J-Z3157		PILOT LIGHT YELLOW	30C/SC (230V MODELS)
	2J-Z2329	1	PILOT LIGHT RED	30CE/SCE/STE (120V & 240V MODELS)
	2J-Z3157		PILOT LIGHT YELLOW	30CE/SCE (230V MODELS)
33	2E-Z1858	1	SWITCH-RED LIGHTED	120V & 240V MODELS
	2E-Z3156		SWITCH-YELLOW LIGHTED	230V MODELS
34	2R-Z1854	2	KNOB W/SET SCREW	30C/SC
35	A5-Z2509	4	PANEL-INSULATOR	30C/SC
36	2I-Z9865	22	O-RING SILICONE, TUBE SEAL	30C/SC serial no. or after C3004650
	2P-Z6455		TUBE SEAL, SOLID	30C/SC, before serial no. C3004650
	2I-Z9865		O-RING SILICONE, TUBE SEAL	30CE/SCE/STE, serial no. or after C3004265
	2P-Z6455		TUBE SEAL, SOLID	30CE/SCE/STE, before serial no. C3004265
37	2I-Z2175	22	ORING SEAL, TUBE GUIDE	30C/SC
38	2P-Z2174	22	TUBE GUIDE	30C/SC
39	2R-Z5846	4	LEGS	30C/SC
40	2K-Z2895	4	ANTI SHORT BUSHING	ALL
41	A5-Z7650	1	ELEMENT RETAINER - UPPER	30C/SC
	A5-RG50107		ELEMENT RTN & TERM MT. CLIPS	30CE/SCE made between 10/2011 to 6/2014
	A5-Z17589		ELEMENT MOUNT UPPER, 11 COUNT	30CE/SCE/STE
42	A5-Z7656	1	ELEMENT RETAINER - LOWER	30C/SC
	A5-Z15194		ELEMENT MT., LOWER 11 CT	30CE/SCE
43	2P-Y9176	2	SNAP BUTTON	Goes with No 44
44	8A-30RGMD		MERCHANDISING DOOR	OPTIONAL ASSESSORY
45	2P-Z5098	11	GREASE SEAL	30CDV/SCDV
46	A5-Z5158	1	GRILL DIVIDER	30CDV/SCDV
47	2D-Z5898	1	PAN 2/3 X 4" DEEP	30CBB/SCBB
48	2P-Z0315	4	DRAWER ROLLER W/SCREW	ALL BUNBOX (CBB/SCBB) MODELS
49	A5-RG3030	1	DRAWER ASSY	30CBB/SCBB
50	A5-RG3009	1	DRAWER FRONT ASSEMBLY	30CBB/SCBB
51	2M-Z2377	1	DRAWER LABEL	30CBB/SCBB
52	2A-Z4677	1	SHAFT	30CBBC/SCBBC
53	A5-Z4660	1	DOOR BRACKET	30CBBC/SCBBC
54	2C-Z4680	1	RETAINER RING	30CBBC/SCBBC
55	A5-Z4661	1	SPRING MOUNT BRACKET	30CBBC/SCBBC
56	A5-Z4657	1	DOOR ARM	30CBBC/SCBBC
57	2P-Z4683	1	EXTENSION SPRING	30CBBC/SCBBC
58	A5-Z6424	1	TONGS	ALL
59	2A-Z4333	2	RETAINER PIN	30CBBC/SCBBC
60	2P-Z4337	1	COMPRESSION SPRING	30CBBC/SCBBC
61	2A-Z4332	2	SHOULDER SCREW	30CBBC/SCBBC
62	A5-RG3037	1	FRONT DOOR	
	A5-RG3016		FRONT DOOR-GLASS	
64	2V-Z17584	2	THERMAL, BLOCK	30SCE/STE
NI	2E-Z8320	1	WIRE SET	30C/SC (INFINITE CONTROLS)
NI	2E-Z8414	1	WIRE SET	30CE/SCE/STE (ELECTRONIC CONTROLS)
NI	2E-Z13637	1	ELEMENT WIRE, FRONT	30CE/SCE/STE (ELECTRONIC CONTROLS)
NI	PS-Z3018	--	TUBE ASSEMBLY SLEEVE	

2M-Z8542: Grill-Max Rollergill, Star Manufacturing International



# PARTS LIST

August 04, 2014, Rev. H

Model: Grill-Max Roller Grills 45 Series				
Fig No	Part No	Qty	Description	Application
1	A5-RG4533	1	BODY ASSY	45C/SC
	A5-RG4536			45CBB/SCBB
	A5-RG4534			45CR/SCR
	A5-RG4537			45CRBB/SCRBB
2	A5-Z2186	1	DRIP TRAY	45C/SC
3	A5-Z8411	1	BACK-CHAIN RETAINER SPACER	45C/SC
4	A5-Z8412	1	ANGLE CHAIN RETAINER UPPER	45C/SC
5	A5-Z2265	2	SIDE PANEL	45C/SC
	A5-Z5347			45CF/SCF
6	2N-Z2178	16	ELEMENT 120V 30/45	45C/SC-120V
	2N-Z2194		ELEMENT 230V 30/45	45C/SC-230V
7	A5-Z6615	1	CHAIN GUIDE	45C/SC
8	2P-Z2266	1	CHAIN	45C/SC
	2P-Z5336			45CF/SCF
9	PS-RG3077	16	ROLLER ASSY CHROME	45C
	A5-RG4565		ROLLER ASSY HI-GRIP 30S/45S	45SC, serial no. or after C4501176
	PS-RG3078		ROLLER ASSY POLY	45SC, serial no. or before C4501175
	A5-RG30166		RLR ASY STALTEK 30ST / 45ST	45STBDE-120V
10	2P-Z8392	3	IDLER SPROCKET	ALL
11	2A-Z8017	3	BUSHING, IDLER	ALL
12	A5-RG30121	1	IDLER ARM ASSY-CHAIN TENS	ALL
13	2P-Z8074	1	SPRING	ALL
14	2P-Z8317	1	MOTOR SPROCKET	ALL 3/8" MOTOR SHAFTS
	2P-Z11853			ALL 1/2" MOTOR SHAFTS
15	2U-Z11854	1	MOTOR GEAR, 120V	120V, w/ 1/2" DIA SHAFT
	PS-RG5069		KIT MOTOR, SPROCKET-120V	120V, w/SPROCKET & MNT PLATE
	PS-RG5072		KIT MOTOR, SPROCKET-120V FLAT	120V, FLAT w/SPROCKET & MNT PLATE
	2U-Z11855		MOTOR GEAR, 240V	230/240V, UNITS w/ 1/2" DIA SHAFT
	PS-RG5070		KIT MOTOR, SPROCKET-230/240V	230/240V, UNITS w/SPROCKET & MNT PLATE
	PS-RG5073		KIT MTR, SPROCKET-230/240V FLAT	230/240V, FLAT UNITS w/SPROCKET & MNT PLATE
16	A5-RG2063	1	MOTOR MOUNTING ASSY	45C/SC
	A5-RG5071			45CF/SCF
17	A5-RG2036	1	CORD ASSY 120V	45C/SC (120V MODELS EXCEPT CSA)
	2E-Z0512		CORD SET EUR 10AMP	45C/SC (230V MODELS)
	A5-RG2041		CORD ASSY 120V	45C/SC (120V CSA MODELS)
18	2K-Y3240	1	CORD BUSHING	45C/SC 240V MODELS
	2K-Y2968			45C/SC 120V
	2K-Y2968			45CSA
19	2E-Y9227	1	CORD INLET IEC320 10 AMP	45C/SC (230V MODELS)
20	A5-Z5335	1	BOTTOM COVER PLATE	ALL
21	2P-Z1540	2	HOLE PLUG	ALL EXCEPT CLEAR BUNBOX MODELS
22	A5-Z9344	1	MOUNTING BRACKET	45C/SC
	A5-RG4554		MOUNTING BRACKET ASSY	45CE/SCE
23	PS-RG5095	2	KIT, CONTROL 230/240 VOLT	45C/SC
	PS-RG5094		KIT, CONTROL 120 VOLT	45C/SC
24	2K-Z1971	9	SPACERS	45CE/SCE
26	PS-RG50132	1	KIT, SERVICE FNT PROBE REPL	45CE/SCE, mfg before 7/2014
	2J-Z17919		THERMISTOR, FRONT .125" DIA	45CE/SCE, mfg after 6/2014
27	2J-Z15324	1	THERMISTOR, REAR .125" DIA X 1" LONG	45CE/SCE
28	PS-RG5087	1	KIT, 2E-Z5565 REPLACEMENT	45CE/SCE, mfg before 11/2010
	2E-Z13638		ELECTRONIC CONTROL RG	45CE/SCE, mfg after 11/2010
29	PS-RG3092	1	CONTROL BOARD	45CE/SCE

2M-Z8542: Grill-Max Rollergrill, Star Manufacturing International

# PARTS LIST

August 04, 2014, Rev. H

Model: Grill-Max Roller Grills 45 Series				
Fig No	Part No	Qty	Description	Application
30	A5-Z7651	1	CONTROL PANEL	45C/SC
	A5-Z7753			45CBB/SCBB
	A5-RG3069			45CE/SCE
	A5-RG3071			45CBBE/SCBBE
31	2M-Z8325	1	CONTROL PANEL LABEL	45C
	2M-Z8326			45CBB
	2M-Z8327			45CE
	2M-Z8329			45SC
	2M-Z8330			45SCBB
32	2J-Z2329	3	PILOT LIGHT RED	45C/SC (120V & 240V MODELS)
	2J-Z3157		PILOT LIGHT YELLOW	45C/SC (230V MODELS)
	2J-Z2329	1	PILOT LIGHT RED	45CE/SCE (120V & 240V MODELS)
	2J-Z3157		PILOT LIGHT YELLOW	45CE/SCE (230V MODELS)
33	2E-Z1858	1	SWITCH-RED LIGHTED	120V & 240V MODELS
	2E-Z3156		SWITCH-YELLOW LIGHTED	230V MODELS
34	2R-Z1854	2	KNOB W/SET SCREW	45C/SC
35	A5-Z2510	4	PANEL-INSULATOR	45C/SC
36	2I-Z9865	32	O-RING SILICONE, TUBE SEAL	45C/SC, serial no. or after C4501176
	2P-Z6455		TUBE SEAL, SOLID	45C/SC, serial no. or before C4501175
37	2I-Z2175	32	ORING SEAL	45C/SC
38	2P-Z2174	32	TUBE GUIDE	45C/SC
39	2R-Z5846	4	LEGS	45C/SC
40	2K-Z2895	4	ANTI SHORT BUSHING	ALL
41	A5-Z6619	1	ELEMENT RETAINER - UPPER	45C/SC mfg between 11/2004 to 10/2011
	A5-Z15197		ELEMENT MT,UPPER 16CT	45C/SC mfg. after 10/2011
	A5-Z17588	1	ELEMENT MOUNT UPPER	45CE/45SCE mfg. after 6/2014
42	A5-Z15196	1	ELEMENT MT LOWER 16CT	45C/SC
	A5-RG75125		ELEMENT RET & THERM MT, CLIPS	45CE/SCE 10/2011 to 6/2014
45	2P-Z5098	16	GREASE SEAL	45CDV/SCDV
46	A5-Z5157	1	GRILL DIVIDER	45CDV/SCDV
47	2D-Z5898	1	PAN 2/3 X 4" DEEP	45CBB/SCBB
48	2P-Z0315	4	DRAWER ROLLER W/SCREW	ALL BUNBOX (CBB/SCBB) MODELS
49	A5-RG3030	1	DRAWER ASSY	45CBB/SCBB
50	A5-RG3009	1	DRAWER FRONT ASSEMBLY	45CBB/SCBB
51	2M-Z2377	1	DRAWER LABEL	45CBB/SCBB
58	A5-Z6424	1	TONGS	ALL
NI	2E-Z8320	1	WIRE SET	45C/SC (INFINITE CONTROLS)
NI	2E-Z8414	1	WIRE SET	45CE/SCE (ELECTRONIC CONTROLS)
NI	PS-Z3018	--	TUBE ASSEMBLY SLEEVE	

# PARTS LIST

March 17, 2015, Rev. H

Model: Grill-Max Roller Grills 50 Series				
Fig No.	Part No	Qty	Description	Application
2	A5-Z2305	1	DRIP TRAY	50C/SC
2A	A5-Z4273	1	DRIP TRAY	50SC-ST, 50SCE-ST, 50SC-ST5
2B	A5-RG5012	1	DRIP TRAY ASSY	50SC-ST, 50SCE-ST, 50SC-ST5, 50SCEQT
3	A5-Z8409	1	BACK-CHAIN RETAINER SPACER	50C/SC
4	A5-Z8410	1	ANGLE CHAIN RETAINER UPPER	50C/SC
5	A5-Z2169	2	SIDE PANEL	50C/SC
	A5-Z5401			50CF/SCF
6	2N-Z2179	11	ELEMENT 120V 50	50C/SC-120V
	2N-Z2193		ELEMENT 230V 50/75	50C/SC-230V
7	A5-Z6719	1	CHAIN GUIDE	50C/SC
8	2P-Z2242	1	CHAIN	50C/SC
	2P-Z5384	1	CHAIN	50CF/SCF
9	PS-RG7562	11	ROLLER ASSY CHROME	50C
	A5-RG5057		ROLLER ASSY HI-GRIP	50SC serial no. or after C5003478
	PS-RG7563		ROLLER ASSY POLY	50SC serial no. or before C5003477, 50SCFESW
	A5-RG50109		RLLR ASSY., "J" COAT, 50/75	50SCEQT
	A5-RG75132		RLR ASY STALTECK 50ST / 75ST	50STE, 50STBD, 50STBDE
10	2P-Z8392	3	IDLER SPROCKET	ALL
11	2A-Z8017	3	BUSHING, IDLER	ALL
12	A5-RG30121	1	IDLER ARM ASSY-CHAIN TENS	ALL
13	2P-Z8074	1	SPRING	ALL
14	2P-Z8317	1	MOTOR SPROCKET	ALL 3/8" MOTOR SHAFTS
	2P-Z11853			ALL 1/2" MOTOR SHAFTS
15	2U-Z11854	1	MOTOR GEAR, 120V	120V, w/ 1/2" DIA SHAFT
	PS-RG5069		KIT MOTOR, SPROCKET-120V	120V, w/SPROCKET & MNT PLATE
	PS-RG5072		KIT MOTOR, SPROCKET-120V FLAT	120V, FLAT w/SPROCKET & MNT PLATE
	2U-Z11855		MOTOR GEAR, 240V	230/240V, UNITS w/ 1/2" DIA SHAFT
	PS-RG5070		KIT MOTOR, SPROCKET-230/240V	230/240V, UNITS w/SPROCKET & MNT PLATE
	PS-RG5073		KIT MTR, SPROCKET-230/240V FLAT	230/240V, FLAT UNITS w/SPROCKET & MNT PLATE
16	A5-RG2063	1	MOTOR MOUNTING ASSY	50C/SC
	A5-RG5071		MOTOR MOUNTING ASSY	50CF/SCF
17	A5-RG2036	1	CORD ASSY 120V	50C/SC (120V MODELS EXCEPT CSA), 50SCFESW-120V
	A5-RG2041		CORD SET ASSY 120V CSA	CSA UNITS
	2E-Z0512		CORD SET EUR 10AMP	50C/SC (230V MODELS)
18	2K-Y3240	1	CORD BUSHING	50C/SC 240V
	2K-Y2968			50C/SC 120V
	2K-Y2968			50CSA, 120C
19	2E-Y9227	1	CORD INLET IEC320 10 AMP	50C/SC (230V MODELS)
20	A5-Z5335	1	BOTTOM COVER PLATE	ALL
21	2P-Z1540	2	HOLE PLUG	ALL EXCEPT CLEAR BUNBOX
22	A5-Z9344	1	MOUNTING BRACKET	50C/SC
	A5-RG4554		MOUNTING BRACKET ASSY	50CE/SC
23	PS-RG5095	2	KIT, CONTROL 230/240 VOLT	50C/SC
	PS-RG5094		KIT, CONTROL 120 VOLT	50C/SC
24	2K-Z1971	9	SPACERS	50CE/SCE
26	PS-RG50132	1	KIT, SERVICE FNT PROBE REPL	50CE/SCE, mfg before 7/2014
	2J-Z17919		THERMISTOR, FRONT .125" DIA	50CE/SCE, mfg after 6/2014
27	2J-Z15324	1	THERMISTOR, REAR .125X1.00 LG	50CE/SCE
28	PS-RG5087	1	KIT, 2E-Z5565 REPLACEMENT	50CE/SCE, mfg before 11/2010
	2E-Z13638		ELECTRONIC CONTROL RG	50CE/SCE, mfg after 11/2010
29	PS-RG3092	1	CONTROL BOARD	50CE/SCE
30	A5-Z7751	1	CONTROL PANEL	50C/SC
	A5-Z7850			50CBB/SCBB
	A5-RG7560			50CBBE/SCBBE
	A5-RG7561			50CE/SCE

# PARTS LIST

March 17, 2015, Rev. H

Model: Grill-Max Roller Grills 50 Series				
31	2M-Z8333	1	CONTROL PANEL LABEL	50C
	2M-Z8334			50CBB
	2M-Z8336			50CBBE
	2M-Z8335			50CE
	2M-Z8337			50SC
	2M-Z8338			50SCBB
	2M-Z8340			50SCBBE
	2M-Z8339			50SCE
	2M-Z20304			50SCE-CT (FRENCH DECAL)
32	2J-Z2329	3	PILOT LIGHT RED	50C/SC (120V & 240V MODELS)
	2J-Z3157		PILOT LIGHT YELLOW	50C/SC (230V MODELS)
	2J-Z2329	1	PILOT LIGHT RED	50CE/SC (120V & 240V MODELS)
	2J-Z3157		PILOT LIGHT YELLOW	50CE/SC (230V MODELS)
33	2E-Z1858	1	SWITCH-RED LIGHTED	120V & 240V MODELS
	2E-Z3156		SWITCH-YELLOW LIGHTED	230V MODELS
34	2R-Z1854	2	KNOB W/SET SCREW	50C/SC
35	A5-Z2509	4	PANEL-INSULATOR	50C/SC
36	2I-Z9865	22	O-RING SILICONE, TUBE SEAL	50C/SC serial no. or after C5003478
	2P-Z6455		TUBE SEAL, SOLID	50C/SC serial no. or before C5003477
37	2I-Z2175	22	ORING SEAL	50C/SC
38	2P-Z2174	22	TUBE GUIDE	50C/SC
39	2R-Z5846	4	LEGS	50C/SC
40	2K-Z2895	4	ANTI SHORT BUSHING	ALL
41	A5-Z7650	1	ELEMENT RETAINER - UPPER	50C/SC
	A5-RG50107		ELEMENT RTN & TERM MT. CLIPS	50CE/SCE made between 10/2011 to 6/2014
	A5-Z17589		ELEMENT MOUNT UPPER, 11 COUNT	50CE/SCE made after 6/2014
42	A5-Z15194	1	ELEMENT MT., LOWER 11 CT	50CE/SCE
	A5-Z7656		ELEMENT RETAINER - LOWER	50C/SC
43	2P-Y9176	2	SNAP BUTTON	50SCBDESW120, 50SCESW-120V, 50SCFE-120C, 50SCESW-120
44	8A-50RGMD	optional	MERCHANDISING DOOR	OPTIONAL ASSESSORY
45	2P-Z5098	11	GREASE SEAL	50CDV/SCDV
46	A5-Z5158	1	GRILL DIVIDER	50CDV/SCDV
47	2D-Z5899	1	PAN FULL X 4" DEEP	50CBB/SCBB
48	2P-Z0315	4	DRAWER ROLLER W/SCREW	ALL BUNBOX (CBB/SCBB) MODELS
49	A5-RG5011	1	DRAWER ASSY	50CBB/SCBB
50	A5-RG5004	1	DRAWER FRONT ASSEMBLY	50CBB/SCBB
51	2M-Z2380	1	DRAWER LABEL	50CBB/SCBB
52	2A-Z4677	1	SHAFT	50CBBC/SCBBC
53	A5-Z4660	1	DOOR BRACKET	50CBBC/SCBBC
54	2C-Z4680	1	RETAINER RING	50CBBC/SCBBC
55	A5-Z4661	1	SPRING MOUNT BRACKET	50CBBC/SCBBC
56	A5-Z4657	1	DOOR ARM	50CBBC/SCBBC
57	2P-Z4683	1	EXTENSION SPRING	50CBBC/SCBBC
58	A5-Z6424	1	TONGS	ALL
	2P-Z0584	3		50SCFESW
59	2A-Z4333	2	RETAINER PIN	50CBBC/SCBBC
60	2P-Z4337	1	COMPRESSION SPRING	50CBBC/SCBBC
61	2A-Z4332	2	SHOULDER SCREW	50CBBC/SCBBC
62	A5-RG5016	1	FRONT DOOR-GLASS	50CBBC/SCBBC
64	2V-Z17584	2	THERMAL, BLOCK	50CE/SCE
65	A5-TH0004	-	BODY BACK ASSY, HOLDER	CERTAIN MODELS
66	A5-TH003	-	BODY ASSY, HOLDER	CERTAIN MODELS
67	2P-Z6420	-	SNAP HOOK	CERTAIN MODELS
68	2B-Z6419	-	CABLE ASSY	CERTAIN MODELS
NI	2E-Z8320	1	WIRE SET	50C/SC (INFINITE CONTROLS)
NI	2E-Z8414	1	WIRE SET	50CE/SCE (ELECTRONIC CONTROLS)
NI	PS-Z3018	--	TUBE ASSEMBLY SLEEVE	
NI	2M-Z20187	1	LABEL, CAUTION HOT IN FRENCH	50SCE-CT-120

2M-Z8542: Grill-Max Rollergill, Star Manufacturing International

# PARTS LIST

March 17, 2015, Rev. H

Model: Grill-Max Roller Grills 75 Series				
Fig No.	Part No	Qty	Description	Application
1	A5-RG7545	1	BODY ASSY	75 C/SC
	A5-RG7546			75 CR/SCR
	A5-RG7547			75CF/SCF
	A5-RG7548			75CBB/SCBB
	A5-RG7549			75CRBB/SCRBB
	A5-RG7571			75CFV
	A5-RG7580			75SCESW
2	A5-Z2306	1	DRIP TRAY	75C/SC
3	A5-Z8411	1	BACK-CHAIN RETAINER SPACER	75C/SC
4	A5-Z8412	1	ANGLE CHAIN RETAINER UPPER	75C/SC
5	A5-Z2265	2	SIDE PANEL	75C/SC
	A5-Z5347		SIDE PANEL	75CF/SCF
6	2N-Z2193	16	ELEMENT 230V 50/75	75C/SC-230V
	2N-Z2982		ELEMENT 120V 105 W	75C/SC-120V
7	A5-Z6615	1	CHAIN GUIDE	75C/SC
8	2P-Z2266	1	CHAIN	75C/SC
	2P-Z5336	1	CHAIN	75CF/SCF
9	A5-RG5057	16	ROLLER ASY HIGRIP 50S/75S	75SCE
	PS-RG7562	16	ROLLER ASSY CHROME	75C
	PS-RG7563	16	ROLLER ASSY POLY	75SC
10	2A-Z6614	3	IDLER	ALL
11	2A-Z8017	3	BUSHING, IDLER	ALL
12	2K-Z2895	3	ANTI SHORT BUSHING	ALL
	A5-RG30121	1	IDLER ARM ASSY-CHAIN TENS	ALL
13	2P-Z8074	1	SPRING	ALL
14	2P-Z8317	1	MOTOR SPROCKET	ALL 3/8" MOTOR SHAFTS
	2P-Z11853			ALL 1/2" MOTOR SHAFTS
15	2U-Z11854	1	MOTOR GEAR, 120V	120V, w/ 1/2" DIA SHAFT
	PS-RG5069	1	KIT MOTOR, SPROCKET-120V	120V, w/SPROCKET & MNT PLATE
	2U-Z11855	1	MOTOR GEAR, 240V	230/240V, UNITS w/ 1/2" DIA SHAFT
	PS-RG5070	1	KIT MOTOR, SPROCKET-230/240V	230/240V, UNITS w/SPROCKET & MNT PLATE
16	A5-RG2035	1	MOTOR MOUNTING ASSY	75C/SC
	A5-RG5040	1	MOTOR MOUNTING ASSY	75CF/SCF
17	2E-Y9251	1	CORD SET EUR 16 AMP	75C/SC (230V MODELS)
	A5-RG2034	1	CORD SER 240V W/TERMINALS	75C/SC (240V MODELS)
	A5-RG2041	1	CORD ASSY 120V	75C/SC (120V MODELS)
18	2K-Y3240	1	CORD BUSHING	75C/SC (120V & 240V MODELS)
19	2E-Y9253	1	CORD INLET IEC320 16 AMP	75C/SC (230V MODELS)
20	A5-Z5335	1	BOTTOM COVER PLATE	ALL
21	2P-Z1540	2	HOLE PLUG	ALL EXCEPT CLEAR BUNBOX MODELS (CBBC, SCBBC)
22	A5-RG7544	1	MOUNTING BRACKET ASSY	75CE/SCE
	A5-Z7664		MOUNTING BRACKET	75C/SC
23	PS-RG5095	2	KIT, CONTROL 230/240 VOLT	75C/SC
	PS-RG5094		KIT, CONTROL 120 VOLT	75C/SC
24	2K-Z1971	9	SPACERS	75CE/SCE
26	PS-RG50132	1	KIT, SERVICE FNT PROBE REPL	75CE/SCE, mfg before 7/2014
	2J-Z17919		THERMISTOR, FRONT .125" DIA	75CE/SCE, mfg after 6/2014
27	2J-Z15324	1	THERMISTOR, REAR .125" DIA X 1" LONG	75CE/SCE
28	PS-RG5087	1	KIT, 2E-Z5565 REPLACEMENT	75CE/SCE, mfg before 11/2010
	2E-Z13638		ELECTRONIC CONTROL RG 120V	75CE/SCE, mfg after 11/2010
	A5-Z13640		ELECTRONIC CONTROL RG 240V	75CE/SCE, mfg after 11/2010

# PARTS LIST

March 17, 2015, Rev. H

Model: Grill-Max Roller Grills 75 Series				
Fig No.	Part No	Qty	Description	Application
30	A5-RG7560	1	CONTROL PANEL	75CE/SCE
	A5-RG7561			75CE/SCE, BUN BOX
	A5-Z7751			75C/SC
	A5-Z7850			75CBB/SCBB
31	2M-Z8333	1	CONTROL PANEL LABEL	75C
	2M-Z8334			75CBB
	2M-Z8335			75CE
	2M-Z8336			75CBBE
	2M-Z8337			75SC
	2M-Z8338			75SCBB
	2M-Z8339			75SCE
	2M-Z8340			75SCBBE
32	2J-Z2329	1	PILOT LIGHT RED	75CE/SCE (120V & 240V MODELS)
		3	PILOT LIGHT RED	75C/SC (120V & 240V MODELS)
	2J-Z3157	1	PILOT LIGHT YELLOW	75CE/SCE (230V MODELS)
		3	PILOT LIGHT YELLOW	75C/SC (230V MODELS)
33	2E-Z1858	1	SWITCH-RED LIGHTED	120V & 240V MODELS
	2E-Z3156		SWITCH-YELLOW LIGHTED	230V MODELS
34	2R-Z1854	2	KNOB W/SET SCREW	75C/SC
35	A5-Z2510	4	PANEL-INSULATOR	75C/SC
36	2P-Z6455	32	TUBE SEAL, SOLID	75C/SC
37	2I-Z2175	32	ORING SEAL	75C/SC
38	2P-Z2174	32	TUBE GUIDE	75C/SC
39	2R-Y5092	4	LEGS 4"	75C/SC
40	2K-Z2895	4	ANTI SHORT BUSHING	ALL
41	A5-Z6619	1	ELEMENT RETAINER - UPPER	75C/SC mfg between 11/2004 to 10/2011
	A5-Z15197		ELEMENT MT,UPPER 16CT	75C/SC mfg. after 10/2011
	A5-Z17588		ELEMENT MT,UPPER 16CT	75CE/SCE mfg. after 6/2014
42	A5-RG75125	1	ELEMENT RET & THERM MT, CLIPS	75CE/SCE 10/2011 to 6/2014
	A5-Z15196		ELEMENT MT LOWER 16CT	
43	2P-Y9176	2	SNAP BUTTON	75SCF-SA, 75SCFE-SA
44	A5-RG7516	1	CONTROL PANEL COVER	75SCF-SA, 75SCFE-SA, 75SCESW
45	2P-Z5098	16	GREASE SEAL	75CDV/SCDV
46	A5-Z5157	1	GRILL DIVIDER	75CDV/SCDV
47	2D-Z5899	1	PAN FULL X 4" DEEP	75CBB/SCBB
48	2P-Z0315	4	DRAWER ROLLER W/SCREW	ALL BUNBOX (CBB/SCBB) MODELS
49	A5-RG5011	1	DRAWER ASSY	75CBB/SCBB
50	A5-RG5004	1	DRAWER FRONT ASSEMBLY	75CBB/SCBB
51	2M-Z2380	1	DRAWER LABEL	75CBB/SCBB
58	A5-Z6424	1	TONGS	ALL
64	2V-Z17584	2	THERMAL, BLOCK	75CE/SCE
65	A5-TH0004	-	BODY BACK ASSY, HOLDER	CERTAIN MODELS
66	A5-TH003	-	BODY ASSY, HOLDER	CERTAIN MODELS
67	2P-Z6420	-	SNAP HOOK	CERTAIN MODELS
68	2B-Z6419	-	CABLE ASSY	CERTAIN MODELS
NI	2E-Z8320	1	WIRE SET	75C/SC (INFINITE CONTROLS)
NI	2E-Z8414	1	WIRE SET	75CE/SCE (ELECTRONIC CONTROLS)
NI	PS-RG7599	AR	CHAIN REPAIR KIT 75 FLAT	FLAT ROLLER CHAIN REP SER. KIT

2M-Z8542: Grill-Max Rollergriil, Star Manufacturing International



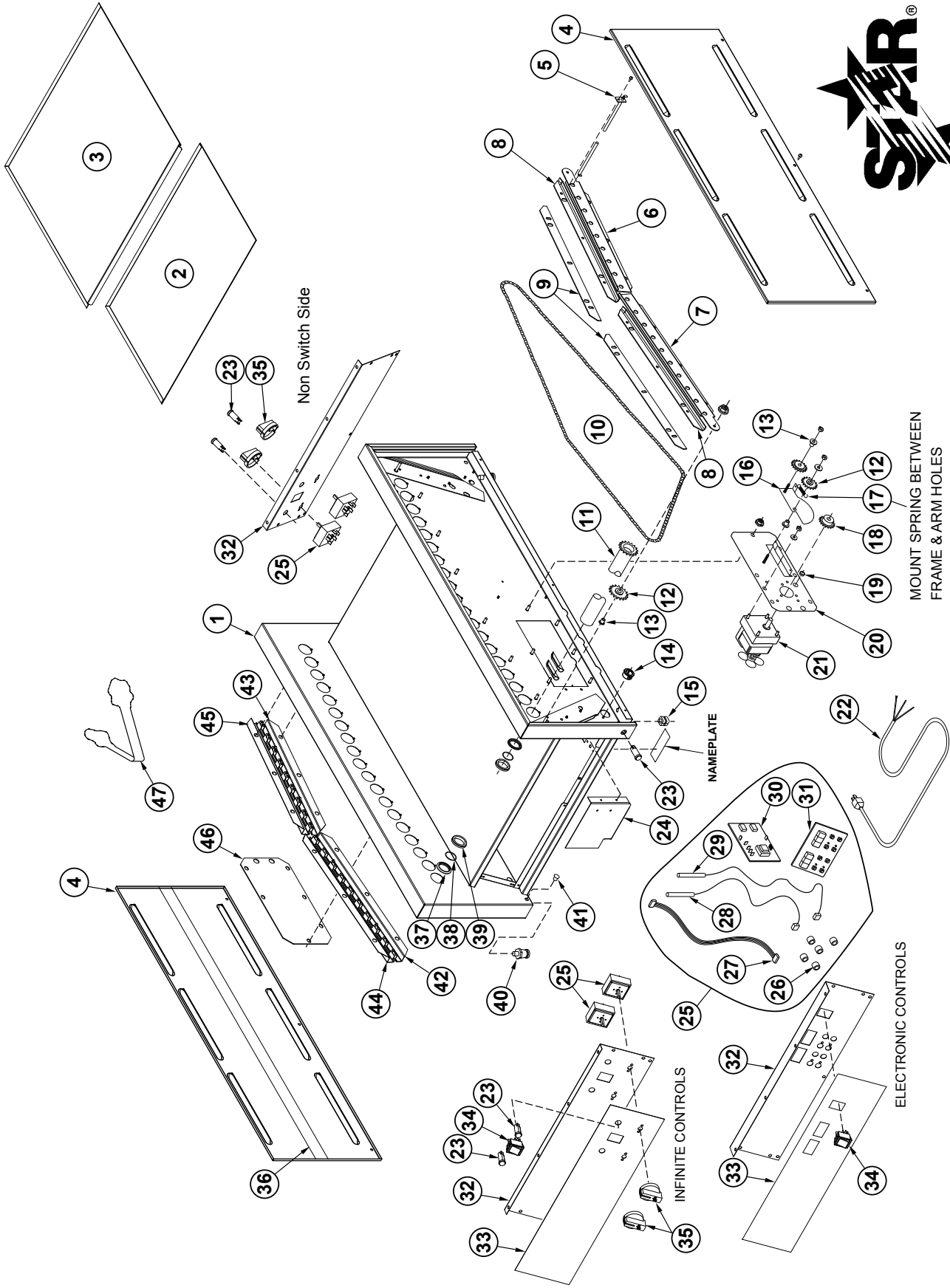

**STAR MANUFACTURING INTERNATIONAL INC.**  
 SK2211 7-05-06

REFER TO THE PARTS LIST SPECIFIC TO YOUR MODEL FOR MORE DETAIL INFORMATION.



# PARTS LIST

September 23, 2008 Rev. H

**Grill-Max Island Roller Grills**  
**MODEL 54IC Series**

Key Number	Part Number	Number Per Unit	Description & Model Designation
1	A5-RG3098	1	BODY ASSY 54IC/ISC
2	A5-Z5185	1	DRIP TRAY
3	A5-RG30105	1	DRIP PAN ASSY 54IC/ISC
4	A5-Z8803	2	SIDE PANEL IC/ISC
5	A5-Z9705	19	ELEMENT 90W 120V 54IC/ISC
6	A5-Z8811	1	CHAIN GUIDE 2
7	A5-Z8810	1	CHAIN GUIDE 1
8	A5-Z8826	2	CHAIN RETAINER-ANGLE
9	A5-Z8827	2	CHAIN RETAINER-FLAT
10	2P-Z8915	1	ROLLER CHAIN
11	A5-RG3001	19	ROLLER ASSY CHROME 54IC
	A5-RG3002	19	ROLLER ASSY POLY 54ISC
12	2P-Z8392	4	IDLER SPROCKET ASSY
13	2A-Z8017	4	BUSHING IDLER
14	2K-8043	1	BUSHING HEYCO
15	2K-Y3240	1	BUSHING SR 17-2 ICE/ISCE
16	A5-RG2042	1	ARM ASSY-CHAIN TENSIONER
17	2P-Z8074	1	EXTENSION SPRING
18	2P-Z8317	1	MOTOR SPROCKET
19	2K-Z2895	3	BUSHING IC/ISC
	2K-Z2895	4	BUSHING ICE/ISCE
20	A5-RG2046	1	MOTOR MOUNTING ASSY
21	2U-Z6485	1	GEAR MOTOR, 120V
22	A5-RG2036	1	CORD SET 120V W/TERMINALS
23	2J-Z2329	5	PILOT LIGHT IC/ISC
	2J-Z2329	2	PILOT LIGHT ICE/ISCE
24	A5-RG4554	2	INSIDE MOUNTING ASSY ICE/ISCE
	A5-Z9344	2	INSIDE MOUNTING BRACKET 54IC/ISC
25	2J-Z2195	4	INFINITE CONTROLS 120V IC/ISC
26	2K-Z1971	18	SPACER ICE/ISCE
27	2E-Z5565-5	2	RIBBON CONNECTOR ICE/ISCE
28	2E-Z5565-3	2	SENSOR FRONT ICE/ISCE
29	2E-Z5565-4	2	SENSOR REAR ICE/ISCE
30	2E-Z5565-2	2	POWER BOARD ICE/ISCE
31	PS-RG3092	2	CONTROL BOARD ICE/ISCE
32	A5-RG3069	1	CONTROL PANEL ICE/ISCE
	A5-Z7651	2	CONTROL PANEL 54IC/ISC
33	2M-Z8325	1	LABEL-CNTRL PNL-SWITCH SIDE 54IC
	2M-Z8327	1	LABEL-CNTRL PNL-SWITCH SIDE 54ICE
	2M-Z8329	1	LABEL-CONTROL PANEL-SWITCH SIDE 54ISC
	2M-Z8332	1	LABEL-CNTRL PNL-SWITCH SIDE 54ISCE
	2M-Z8916	1	LABEL 2 CNTRL PNL-NON SWITCH SIDE 54ISC
	2M-Z9723	1	CONTROL PNL LABEL-NON SWITCH SIDE 54IC/ISC
	2M-Z9724	1	CONTROL PNL LABEL-NON SWITCH SIDE 54ICE/ISCE
	2M-Z9725	1	CNTRL PNL LABEL 2 - NON SWITCH SIDE 54ISCE
34	2E-Z1858	1	SWITCH-LIGHTED
35	2R-Z1854	4	KNOB-CONTROL IC/ISC
36	A5-Z2509	4	PANEL INSULATOR
37	2P-Z6455	38	TUBE SEAL, SOLID
38	2I-Z2175	38	O-RING SEAL
39	2P-Z2174	38	TUBE GUIDE
40	2R-Z5846	4	FOOT-ROLLER GRILLS 54IC/ISC

**IMPORTANT: WHEN ORDERING, SPECIFY VOLTAGE OR TYPE GAS DESIRED  
 INCLUDE MODEL AND SERIAL NUMBER**

PAGE 1  
 OF 2

Some items are included for illustrative purposes only and in certain instances may not be available.

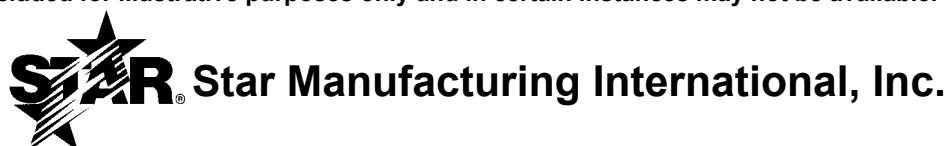

# PARTS LIST

September 23, 2008 Rev. H

Grill-Max Island Roller Grills  
MODEL **54IC Series**

Key Number	Part Number	Number Per Unit	Description & Model Designation
41	2P-Z1540	5	PLUG-HEYCO 5/16" DIA. IC/ISC
	2P-Z1540	4	PLUG-HEYCO 5/16" DIA. ICE/ISCE
42	A5-RG30115	1	ELEMENT RETAINER ASSY LOWER 1 ICE/ISCE
	A5-Z8808	1	ELEMENT RETAINER-LOWER 1 IC/ISC
43	A5-RG30116	1	ELEMENT RETAINER ASSY LOWER 2 ICE/ISCE
	A5-Z8809	1	ELEMENT RETAINER-LOWER 2 IC/ISC
44	A5-Z8828	1	ELEMENT RETAINER-UPPER 1
45	A5-Z8829	1	ELEMENT RETAINER-UPPER 2
46	A5-Z8833	1	COVER PLATE
47	A5-Z6424	1	TONGS-PLASTIC
NI	2E-Z8912	1	WIRE SET IC/ISC
NI	2E-Z9789	1	WIRE KIT ICE/ISCE

**IMPORTANT: WHEN ORDERING, SPECIFY VOLTAGE OR TYPE GAS DESIRED  
INCLUDE MODEL AND SERIAL NUMBER**

PAGE 2  
OF 2

Some items are included for illustrative purposes only and in certain instances may not be available.

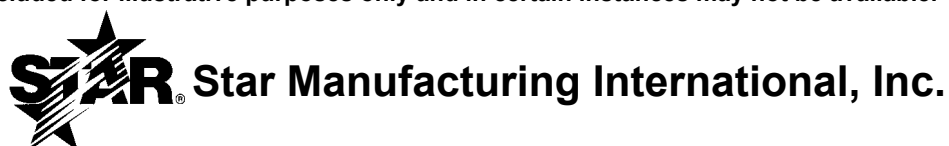

# PARTS LIST

September 23, 2008 Rev. H

**Grill-Max Island Roller Grills**  
**MODEL 90IC/ISC Series**

Key Number	Part Number	Number Per Unit	Description & Model Designation
1	A5-RG7575	1	BODY ASSY 90IC/ISC
2	A5-Z9828	1	DRIP TRAY 90IC/ISC
3	A5-RG7576	1	DRIP PAN ASSY 90IC/ISC
4	A5-Z8803	2	SIDE PANEL IC/ISC
5	2N-Z2193	19	ELEMENT 135W, 230V 90IC/ISC
6	A5-Z8811	1	CHAIN GUIDE 2
7	A5-Z8810	1	CHAIN GUIDE 1
8	A5-Z8826	2	CHAIN RETAINER-ANGLE
9	A5-Z8827	2	CHAIN RETAINER-FLAT
10	2P-Z8915	1	ROLLER CHAIN
11	A5-RG7501	19	ROLLER ASSY CHROME 90IC
	A5-RG7502	19	ROLLER ASSY POLY 90ISC
12	2P-Z8392	4	IDLER SPROCKET ASSY
13	2A-Z8017	4	BUSHING IDLER
14	2K-8043	1	BUSHING HEYCO
15	2K-Y3240	1	BUSHING SR 17-2 ICE/ISCE
16	A5-RG2042	1	ARM ASSY-CHAIN TENSIONER
17	2P-Z8074	1	EXTENSION SPRING
18	2P-Z8317	1	MOTOR SPROCKET
19	2K-Z2895	8	BUSHING 90IC/ISC
19	2K-Z2895	4	BUSHING ICE/ISCE
20	A5-RG2046	1	MOTOR MOUNTING ASSY
21	2U-Z6487	1	GEAR MOTOR, 240V
22	A5-RG2034	1	CORD SET 240V W/TERMINALS 90ICE
	A5-RG7579	1	CORD W/TERMINALS 240V, 6-15P 90IC
23	2J-Z2329	6	PILOT LIGHT IC/ISC
	2J-Z2329	2	PILOT LIGHT ICE/ISCE
24	A5-RG4554	2	INSIDE MOUNTING ASSY ICE/ISCE
	A5-Z7664	2	INSIDE MOUNTING BRACKET 90IC/ISC
25	2J-Z2192	4	INFINITE CONTROLS 240V IC/ISC
26	2K-Z1971	18	SPACER ICE/ISCE
27	2E-Z5565-5	2	RIBBON CONNECTOR ICE/ISCE
28	2E-Z5565-3	2	SENSOR FRONT ICE/ISCE
29	2E-Z5565-4	2	SENSOR REAR ICE/ISCE
30	2E-Z5565-2	2	POWER BOARD ICE/ISCE
31	PS-RG3092	2	CONTROL BOARD ICE/ISCE
32	A5-RG7560	1	CONTROL PANEL 90ICE/ISCE
	A5-Z7751	2	CONTROL PANEL 90IC/ISC
33	2M-Z8333	1	LABEL-CONTROL PNL-SWITCH SIDE 90IC
	2M-Z8335	1	LABEL-CONTROL PANEL-SWITCH SIDE 90ICE
	2M-Z8337	1	LABEL-CNTRL PNL-SWITCH SIDE 90ISC
	2M-Z8339	1	LABEL-CNTRL PNL-SWITCH SIDE 90ISCE
	2M-Z8938	1	LABEL-CNTRL PNL-NON-SWITCH SIDE 90ISC
	2M-Z9727	1	CONTROL PNL LABEL-NON SWITCH SIDE 90ICE
	2M-Z9727	1	CONTROL PNL LABEL-NON SWITCH SIDE 90IC
	2M-Z9728	1	LABEL-CNTRL PNL-NON-SWITCH SIDE 90ISCE
34	2E-Z1858	1	SWITCH-LIGHTED
35	2R-Z1854	4	KNOB-CONTROL ICE/ISC
36	A5-Z2509	4	PANEL INSULATOR
37	2P-Z2174	38	TUBE GUIDE
38	2I-Z2175	38	O-RING SEAL
39	2P-Z6455	38	TUBE SEAL, SOLID

**IMPORTANT: WHEN ORDERING, SPECIFY VOLTAGE OR TYPE GAS DESIRED**  
**INCLUDE MODEL AND SERIAL NUMBER**

PAGE 1  
 OF 2

Some items are included for illustrative purposes only and in certain instances may not be available.

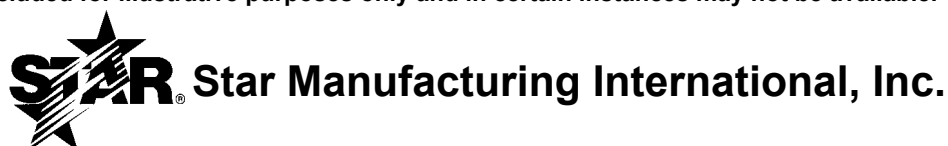

# PARTS LIST

September 23, 2008 Rev. H

Grill-Max Island Roller Grills  
 MODEL **90IC/ISC Series**

Key Number	Part Number	Number Per Unit	Description & Model Designation
40	2R-Y5092	4	BLACK PLASTIC LEG 90IC/ISC
41	2P-Z1540	5	PLUG-HEYCO 5/16" DIA. IC/ISC
	2P-Z1540	4	PLUG-HEYCO 5/16" DIA. ICE/ISCE
42	A5-RG30115	1	ELEMENT RETAINER ASSY LOWER 1 ICE/ISCE
	A5-Z8808	1	ELEMENT RETAINER-LOWER 1 IC/ISC
43	A5-RG30116	1	ELEMENT RETAINER ASSY LOWER 2 ICE/ISCE
	A5-Z8809	1	ELEMENT RETAINER-LOWER 2 IC/ISC
44	A5-Z8828	1	ELEMENT RETAINER-UPPER 1
45	A5-Z8829	1	ELEMENT RETAINER-UPPER 2
46	A5-Z8833	1	COVER PLATE
47	A5-Z6424	1	TONGS-PLASTIC
NI	2E-Z8912	1	WIRE SET 90IC/ISC
NI	2E-Z9789	1	WIRE SET 90ICE/ISCE

**IMPORTANT: WHEN ORDERING, SPECIFY VOLTAGE OR TYPE GAS DESIRED  
 INCLUDE MODEL AND SERIAL NUMBER**

PAGE 2  
 OF 2

Some items are included for illustrative purposes only and in certain instances may not be available.

