

TRI-LEG, ELECTRIC KETTLES

TILTING, "SPASH PROOF SERIES",
 SELF-CONTAINED, 2/3 STEAM JACKETED,
 25, 40 or 60 GALLONS (100, 150 or 225 LITERS)

MODELS: KEL-25-T
 KEL-40-T
 KEL-60-T

Cleveland Standard Features

- Self-contained, easily installed - needs only an electrical hook-up
- Steam jacket filled with treated water, venting and/or refilling is not required
- Accurate, consistent solid state temperature controls (mechanical thermostat not as accurate) - less than $\pm 1^{\circ}\text{C}$ variance (ideal for simmering). Operating temperature range from 145° - 260°F (63°C - 127°C)
 Control panel includes:
 - LED indicator for heat cycle • LED indicator for low water
 - Power ON/OFF switch • Adjustable temperature control dial
- Water resistant controls, splash-proof construction
- Large pouring lip for high capacity and chunky products
- Re-inforced rolled rim design prevents damage to kettle rim, eliminates "bar rim designs"
- Welded-in heating elements, (holds vacuum better, won't leak or loose water)
- Easily cleaned: kettle and all exterior surfaces are of type 304 stainless steel with an #4 finish
- Rear mounted easy access pressure gauge and pressure relief valve to prevent tampering. Color coded easy to read pressure gauge with "green" and "vent air zone"
- 50 psi steam jacket rating for higher cooking temperatures
- 50 psi safety valve
- Solid state water level control (no sight glass gauge to break or leak)
- Splash proof element cover with a double gasket seal
- Tilt mechanism of roller bearings and case hardened self-locking worm and segment gear
- 1 5/8" O.D. tri-leg supports with level adjustable feet for floor bolting
- Standard voltage is 208-240 volts, 60 Hz, 3-phase, 3-wire
- Typical approvals include UL., CSA, CE, NSF and ASME

Options & Accessories

- Spring-assisted, hinged, rotatable, domed Stainless Steel Cover (CHS)
- 2" or 3" diameter Tangent Draw-Off Valve (TD2 or TD3*), *TD3 for 60 gallon only and will raise height of kettle by 5-5/8" (143mm)
- Hot and Cold Water Faucet with Swing Spout and Mounting Bracket (DPK and FBKT)
- Type 316 Stainless Steel Kettle Liner for high acid food products (316)
- Pan Carrier (PCK)
- Flow Diverter (FD)
- Food Strainers (FS)
- Cooking Baskets and Tri-Basket Supports (BS and TBS)
- Kettle Accessory Kit (KAK) includes:
 - Clean-up Brush (CB)
 - 36" Kettle Paddle (KP)
 - 36" Kettle Whip (KW)
 - 36" Kettle Brush
 - Draw-Off Brush (DB)
 - 24 oz. Ladle (KL)
- Automatic Water Meter (GMF or LMF)



Shown with optional spring-assisted cover and 2" tangent draw-off valve

Short Form Specifications

Shall be CLEVELAND, Electric Kettle, Tri-leg mounted, self-contained, tilting, Model KEL - ____ - T; ____ gallons, 2/3 Steam Jacketed. Type 304 Stainless Steel Kettle and Supports. 50 psi Steam Jacket Rating, 50 psi Safety Valve, Permanently filled Steam Jacket, Combination Pressure/Vacuum Jacket Gauge. Splash Proof Solid State Temperature ($\pm 1^{\circ}\text{C}$) and Safety Control System in plug-in Module including L.E.D. indicators,

- Drain Strainers (DS-)
- Water Meter Stand (SWM)
- Lift-Off Covers (CL)
- Measuring Strip (MS)
- Gallon Markings (KM)
- Hot and cold or cold only Kettle Filler with 60" Hose (DKF-K or SKF-K)
- Swing Funnels for drain (SW)
- Alternate Mounting Systems
- High Wattage (HW) (see back page)
- Special Voltages (see back page)
- Heat Deflector Shield (HS001)
- Correctional Packages

CAPACITIES: (in 8 oz. servings,
other sizes may be calculated)
25 Gallon / 100 liters . . . 400 servings
40 Gallon / 150 liters . . . 640 servings
60 Gallon / 225 liters . . . 960 servings

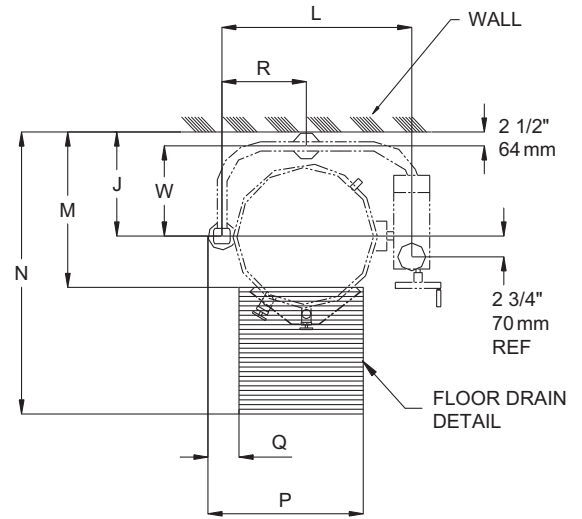
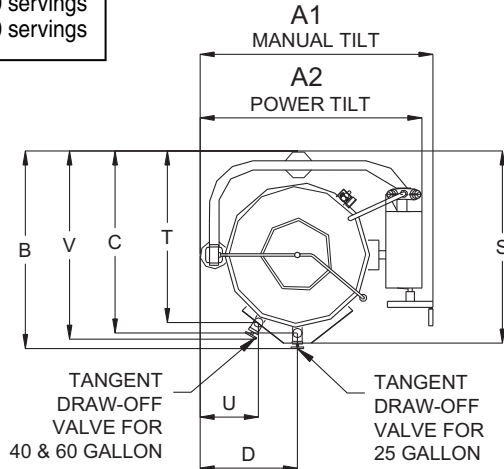
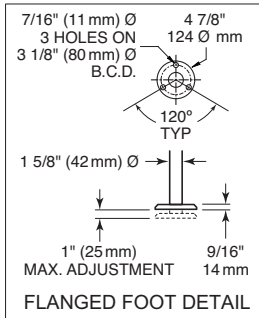

NOTE: TD3, 3" tangent draw off will raise height of kettle by 5-5/8" (143mm). Available on 60 gallon models only.

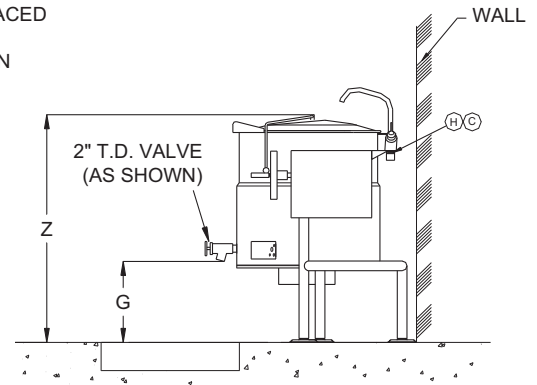
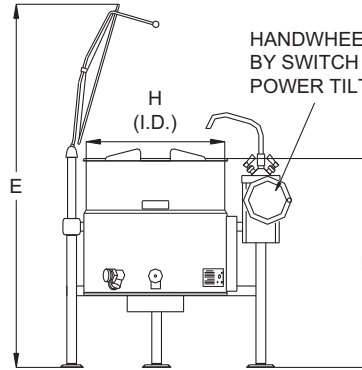
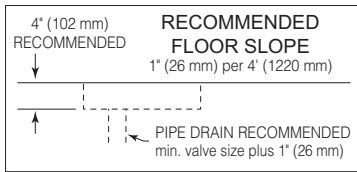

KETTLE SHOWN WITH OPTIONAL SPRING ASSIST COVER, WATER FAUCET AND T.D. VALVE

DIMENSIONS

GALS./LITERS	A1	A2	B	C	D	E	F	G	H	J	L	M	N	P	Q	R	S	T	U	V	W	Z	
25/ IN	36 1/2	31 1/4	33 3/4	29 7/8	15 1/2	62 3/4	37 1/2	14 5/8	21	17	28 3/4	22 1/4	51 3/4	24	4	14 3/8	31					14 1/2	41 1/8
100 mm	928	794	858	759	394	1594	953	372	534	432	731	566	1315	610	102	366	788					369	1045
40/ IN	41 1/2	39 3/8				68 1/2	39 1/2	13 5/8	26	20	33 3/4	26	56	28 1/2	5 1/2	16 13/16	37 3/4	34	5 1/2	37 1/8	17 1/2	42 1/2	
150 mm	1055	1001				1740	1004	347	661	508	858	661	1423	724	140	428	959	864	140	943	445	1080	
60/ IN	45	42 7/8				75 3/4	42 1/2	14 1/8	29 1/2	21 1/2	37 1/4	29 3/4	62 1/2	31	5 1/2	18 9/16	41 1/8	37	7 3/4	38 3/8	19	46 7/8	
225 mm	1143	1090				1925	1080	359	750	547	947	756	1588	788	140	472	1045	940	197	975	483	1191	

STANDARD WATTAGE

GALS. LITERS	208V			240V			415V			480V		
	KW	1PH	3PH	KW	1PH	3PH	KW	1PH	3PH	KW	1PH	3PH
25	9.8	47.2	27.2	13.1	54.4	31.4	12.1	29.0	16.7	13.1	27.2	15.7
40	14.7	70.8	40.9	19.6	81.7	47.1	18.1	43.5	25.1	19.6	40.8	23.6
60	22.5	107.0	61.4	29.4	118.0	70.6	27.1	65.2	37.6	29.4	61.4	37.6

HIGH WATTAGE

GALS. LITERS	208V			240V			415V			480V		
	KW	1PH	3PH	KW	1PH	3PH	KW	1PH	3PH	KW	1PH	3PH
25	14.7	70.8	40.9	19.6	81.7	47.1	18.1	43.5	25.1	19.6	40.8	23.6
40	24.5	NA	68.1	32.7	NA	78.6	30.1	72.5	41.8	32.7	68.1	39.3
60	29.4	NA	81.7	39.2	NA	94.3	36.2	87.0	50.2	39.2	81.7	47.1

Consult factory for other voltages.

NOTES:

Cleveland Range reserves right of design improvement or modification, as warranted.
Many regional, state and local codes exist and it is the responsibility of the owner and installer to comply with the codes.
Cleveland Range equipment is built to comply with applicable standards for manufacturers. Included among those approval agencies are U.L., NSF, CGA, CSA, ETL and others.

WATER

3/8" O.D. copper tube or 1/2" N.P.T. pipe.

When ordered with optional faucet.

CLEARANCE

RIGHT = 4.0" handle clearance

LEFT = .00"

REAR = 2.5"

(NOT TO SCALE)

SECT. VIII PAGE 10

0609

Litho in U.S.A.