



Pop-Up Toaster

IMPORTANT! — HOW TO USE THIS PARTS LIST

This Replacement Parts List includes sections for several different versions/revisions of the TPT Series Pop-Up Toasters. Each of these versions were given a specific **Item** number—"TPT120", "TPT208.R01", "TPT3.120", etc... The **Item** number is printed on the top, right side of the specification label. The specification label is located on the bottom of each unit (refer to page 2 for a specification label example).

To find the correct replacement parts list for a TPT Series Pop-Up Toaster, locate the specific **Item** number and refer to the appropriate section page numbers listed below:

Item Number	Page #
TPT3.120, TPT3.120CSA, TPT3.208, TPT3.208CSA, TPT3.230-4, TPT3.230SCHUKO, TPT3.230CCC, TPT3.240	2-3
TPT120, TPT120CA, TPT-120, TPT-120CA, TPT-120CA-15A	4-5
TPT120.R01, TPT120CA.R01, TPT-230R-4	6-7
TPT208, TPT208CA, TPT208.R01, TPT208CA.R01, TPT240, TPT240.R01, TPT-230-4	8-10

TPT Series

TPT-120
TPT-120R

TPT-208
TPT-240

TPT-230-4
TPT-230R

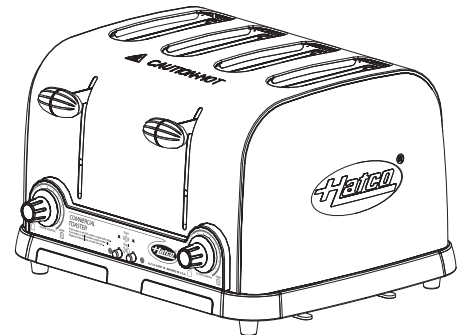
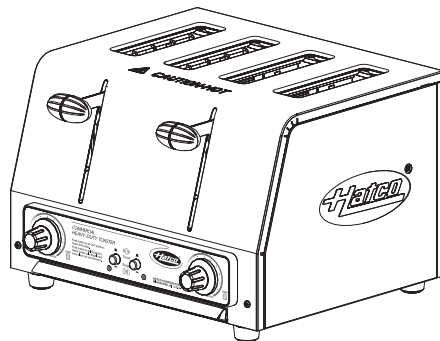
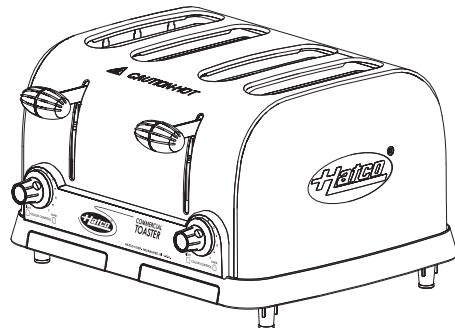

CAUTION

Use of replacement parts other than those supplied by Hatco Corporation may result in damage to unit or injury to personnel and will void all warranties.

See "IMPORTANT!" information in each section of this Replacement Parts List to locate the correct part numbers for a specific model.

Replacement Parts List

HATCO POP-UP TOASTER

TPT-120, TPT-208, TPT-240, TPT-230-4 Models

Model Designation

TPT-XXX-4

Qty. of Toasting Slots
Voltage
Toaster Pop-Up Type

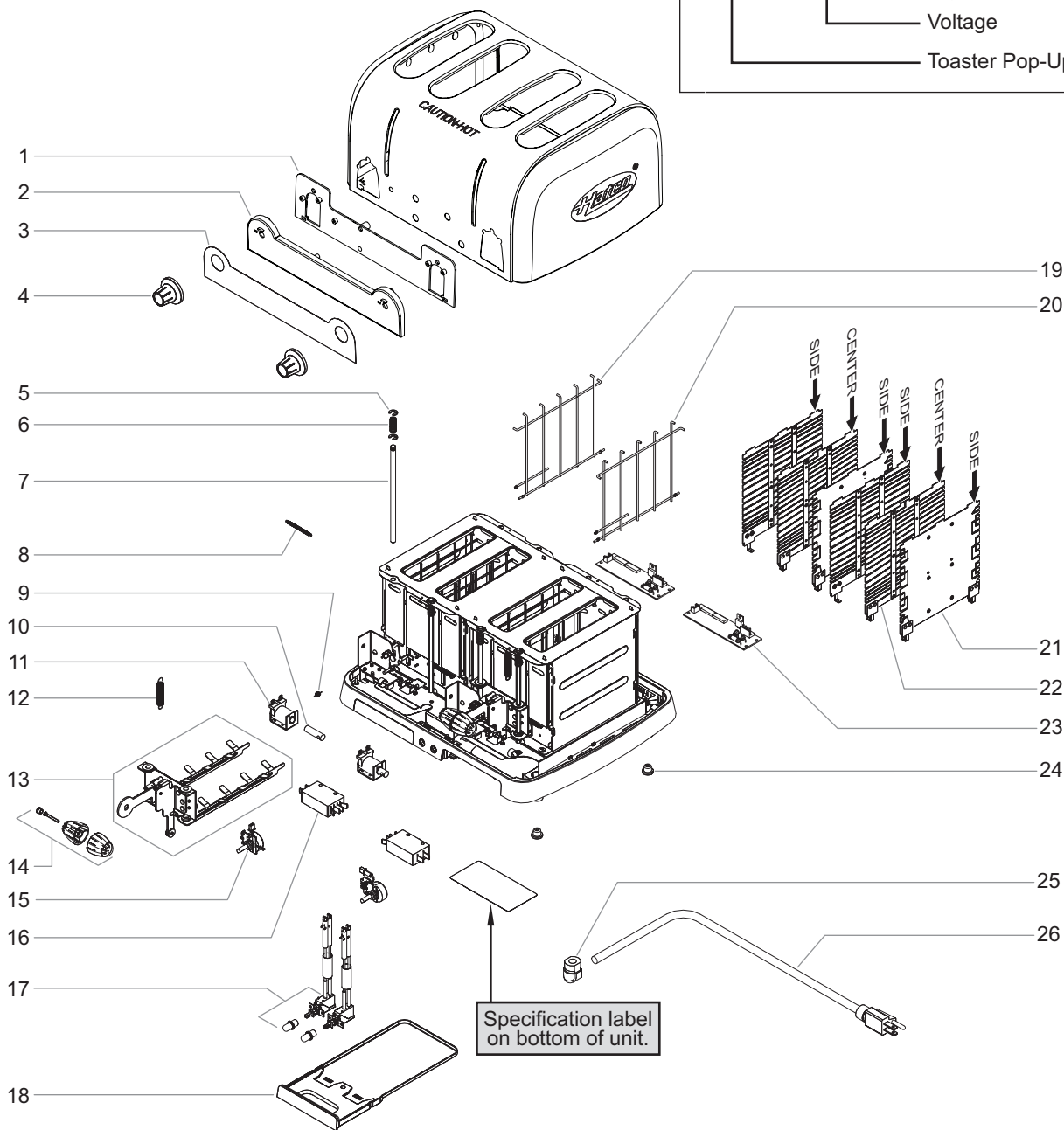

IMPORTANT! — HOW TO USE THIS SECTION

This section of the TPT Series Replacement Parts List includes part numbers for different versions/revisions of the TPT-120, TPT-208, TPT-240, and TPT-230-4 Model Pop-Up Toasters. Each of these versions were given a specific **Item** number—“TPT3.120”, “TPT3.208”, “TPT3.230-4”, etc... The **Item** number is printed on the top, right side of the specification label. The specification label is located on the bottom of the unit.

To find the correct replacement parts for a TPT-120, TPT-208, TPT-240, or TPT-230-4 Model Pop-Up Toaster, locate the specific **Item** number and refer to the appropriate column in the table on the next page.

Part numbers of “---” indicate the item is not available for the designated unit.

HATCO CORPORATION, MILWAUKEE, WIS. U.S.A.
MADE IN U.S.A.
Model: TPT-120 S/N: 1234610801 **Item: TPT3.120**

	~VAC	WIRE	WATTS	PH	Hz
CIRCUIT 1:	120	2	1800	15.0	1 60

U.L. File
E42639

Example of a TPT-120 Specification Label



TPT-120, TPT-208, TPT-240, TPT-230-4 MODELS PARTS LIST

Item	Description	Item #s: TPT3.120 TPT3.120CSA	Item #s: TPT3.208 TPT3.208CSA	Item #s: TPT3.230-4 TPT3.230SCHUKO TPT3.230CCC TPT3.240	Qty.
		Part Number	Part Number	Part Number	
1	Bracket, Control Panel	04.05.643.00	04.05.643.00	04.05.643.00	1
2	Control Panel	04.05.644.00	04.05.644.00	04.05.644.00	1
3	Decal, Control Panel ■	07.01.329.00	07.01.360.00	07.01.360.00	1
4	Knob, Color Control	05.30.115.00	05.30.115.00	05.30.115.00	2
5	E-Ring	05.04.558.00	05.04.558.00	05.04.558.00	8
6	Damping Spring	05.08.017.00	05.08.017.00	05.08.017.00	4
7	Carriage Shaft	05.07.042.00	05.07.042.00	05.07.042.00	4
8	Spring, Extension	05.08.019.00	05.08.019.00	05.08.019.00	4
9	Return Spring, Solenoid	05.08.015.00	05.08.015.00	05.08.015.00	2
10	Plunger, Solenoid	02.20.343.00	02.20.343.00	02.20.343.00	2
11	Solenoid	02.20.342.00	02.20.407.00	02.20.407.00	2
12	Carriage Spring	05.08.034.00	05.08.034.00	05.08.034.00	2
13	Carriage Handle Assembly	04.05.783.00	04.05.783.00	04.05.783.00	2
14	Knob, Carriage Handle Assembly	R05.30.133.00	R05.30.133.00	R05.30.133.00	2
15	Potentiometer, Color Control	02.18.484.00	02.18.484.00	02.18.484.00	2
16	Micro Switch, DPDT	02.19.193.00	02.19.193.00	02.19.193.00	2
17	Selector Switch ■	---	02.18.452.00	02.18.452.00	2
18	Crumb Tray Assembly	04.05.795.00	04.05.795.00	04.05.795.00	2
19	Wire Guide, Left	04.05.781.00	04.05.781.00	04.05.781.00	4
20	Wire Guide, Right	04.05.778.00	04.05.778.00	04.05.778.00	4
21	Heating Element Assembly, Side *	02.05.789.00	02.05.799.00	02.05.812.00	4
22	Heating Element Assembly, Center *	02.05.792.00	02.05.798.00	02.05.811.00	2
23	Control Board Assembly ♦	02.01.346.00	02.01.360.00	02.01.360.00	2
24	Rubber Foot	05.30.114.00	05.30.114.00	05.30.114.00	4
25	Cord Grip	02.20.233.00	02.20.233.00	02.20.233.00	1
26	Power Cord and Plug				1
	NEMA 5-15P	02.18.474.00	---	---	1
	NEMA 6-15P (U.S.)	---	02.18.475.00	---	1
	NEMA 6-20P (Canada)	---	02.18.476.00	---	1
	CEE 7/7 Schuko	---	---	02.18.527.00	1
	BS-1363	---	---	02.18.528.00	1
	AS 3112	---	---	02.18.529.00	1
	CH1-10P (CCC)	---	---	02.18.533.00	1
	Wiring Diagram	10-01-631	10-01-1034	10-01-1034	

Shaded area contains information for **International models only**.

- Chinese models (Item # TPT3-230CCC) use Selector Switch P/N 02.18.542.00 and Control Panel Decal P/N 07.01.373.00.
- * Canadian 120 V models (Item # TPT3.120CSA) use P/N 02.05.849.00 (Item 21) and P/N 02.05.847.00 (Item 22).
- ♦ Canadian 120 V models (Item # TPT3.120CSA) use Control Board Assembly P/N 02.01.379.00.

NOTE: The last four digits in a ten digit numerical serial number are the manufacturing date code.

Example: Serial number 9625060951 has a date code of "0951" which indicates the year (09 = 2009) and week (51).

HATCO POP-UP TOASTER
TPT-120 Models

Model Designation
TPT - XXX

└── Voltage
└── Toaster Pop-Up Type

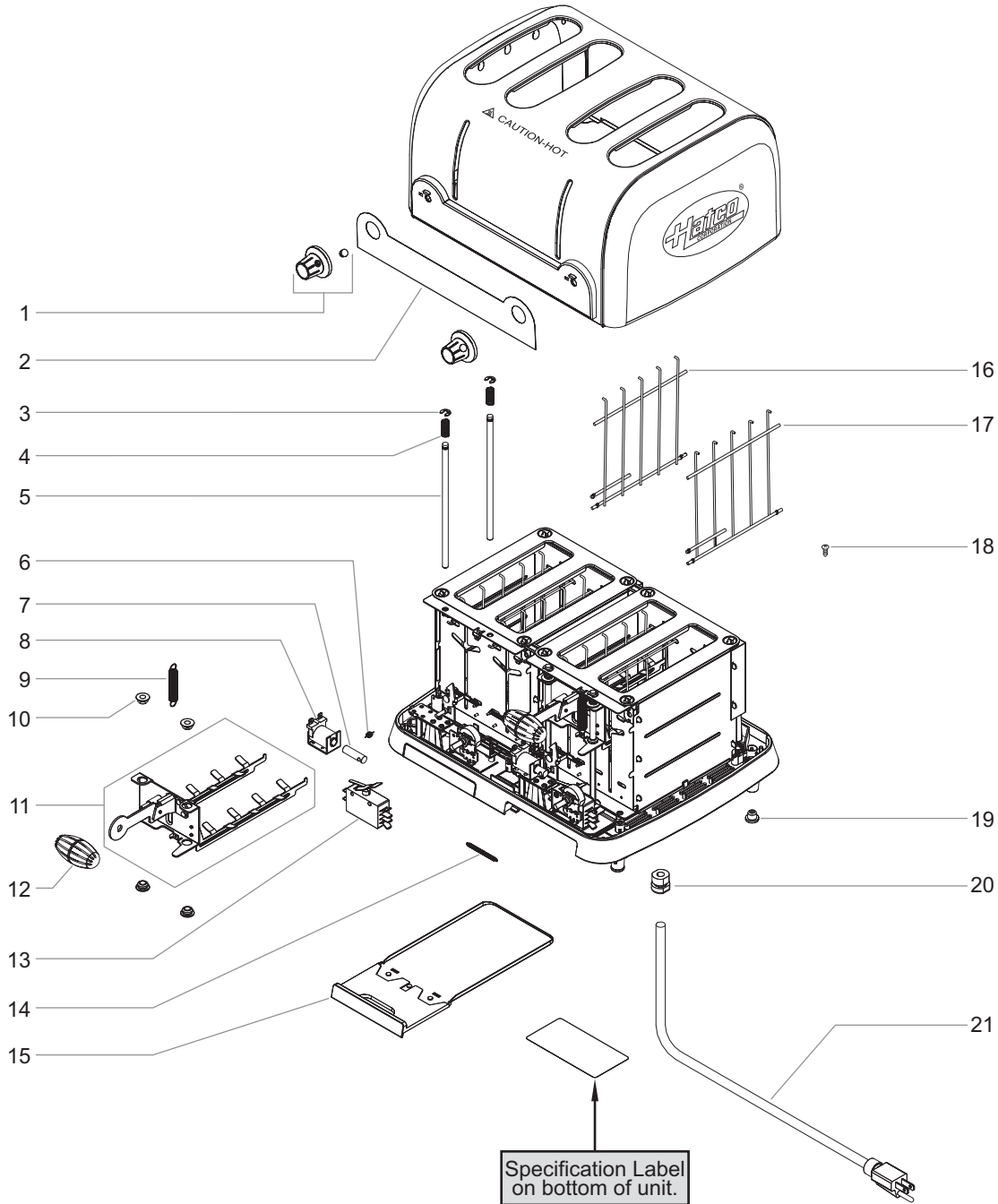

IMPORTANT! — HOW TO USE THIS SECTION

This section of the TPT Series Replacement Parts List includes part numbers for different versions/revisions of the TPT-120 Model Pop-Up Toaster. Each of these versions were given a specific **Item** number—"TPT120", "TPT-120", "TPT120CA", etc... The **Item** number is printed on the top, right side of the specification label. The specification label is located on the bottom of the unit.

To find the correct replacement parts for a TPT-120 Model Pop-Up Toaster, locate the specific **Item** number and refer to the appropriate column in the table below.

Part numbers of "---" indicate the item is not available for the designated unit.

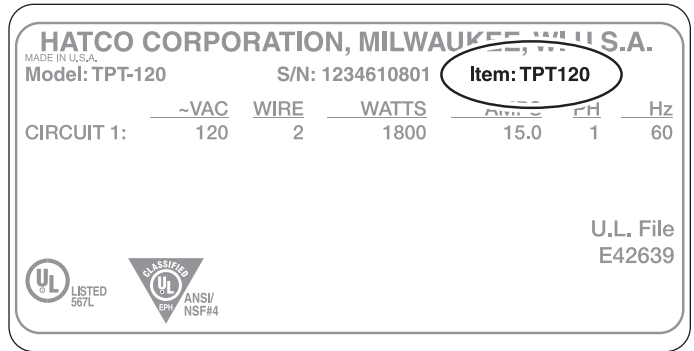

Example of a TPT-120 Specification Label

TPT-120 MODELS PARTS LIST

Item	Description	Item #s: TPT120 TPT120CA	Item #s: TPT-120 TPT-120CA TPT-120CA-15A	Quantity
		Part Number	Part Number	
1	Knob, Color Control	05.30.115.00	05.30.115.00	2
2	Decal, Control Panel	07.01.329.00	07.01.329.00	1
3	E-Ring	05.04.558.00	05.04.558.00	4
4	Damping Spring	05.08.017.00	05.08.017.00	4
5	Carriage Shaft	05.07.032.00	05.07.032.00	4
6	Return Spring, Solenoid	05.08.015.00	05.08.015.00	2
7	Plunger, Solenoid	02.20.343.00	02.20.343.00	2
8	Solenoid	02.20.342.00	02.20.342.00	2
9	Carriage Spring	05.08.016.00	05.08.016.00	2
10	Shaft Bushing	05.02.028.00	05.02.028.00	8
11	Carriage Handle Assembly	X04.05.546.00	04.05.678.00	2
12	Knob, Carriage Handle Assembly	R05.30.133.00	R05.30.133.00	2
13	Micro Switch, DPDT	02.19.193.00	02.19.193.00	2
14	Spring, Extension	05.08.019.00	05.08.019.00	4
15	Crumb Tray Assembly	04.05.547.00	04.05.547.00	2
16	Wire Guide, Left	04.05.671.00	04.05.671.00	1
17	Wire Guide, Right	04.05.649.00	04.05.649.00	1
18	Screw	05.04.559.00	---	16
19	Rubber Foot	05.30.114.00	05.30.114.00	4
20	Cord Grip	02.20.357.00	02.20.357.00	1
21	Power Cord and Plug *	02.18.154.00	02.18.154.00	1
22	Heating Element Assembly	---	---	
	Wiring Diagram	10-01-630	10-01-630	

* 20 A Canadian models (Item # TPT-120CA) use P/N 02.18.089.00

NOTE: The last four digits in a ten digit numerical serial number are the manufacturing date code.

Example: Serial number 9625060951 has a date code of "0951" which indicates the following: 0951

└─ Week Fifty-One
└─ Year 2009

HATCO POP-UP TOASTER

TPT-120R and TPT-230R Model

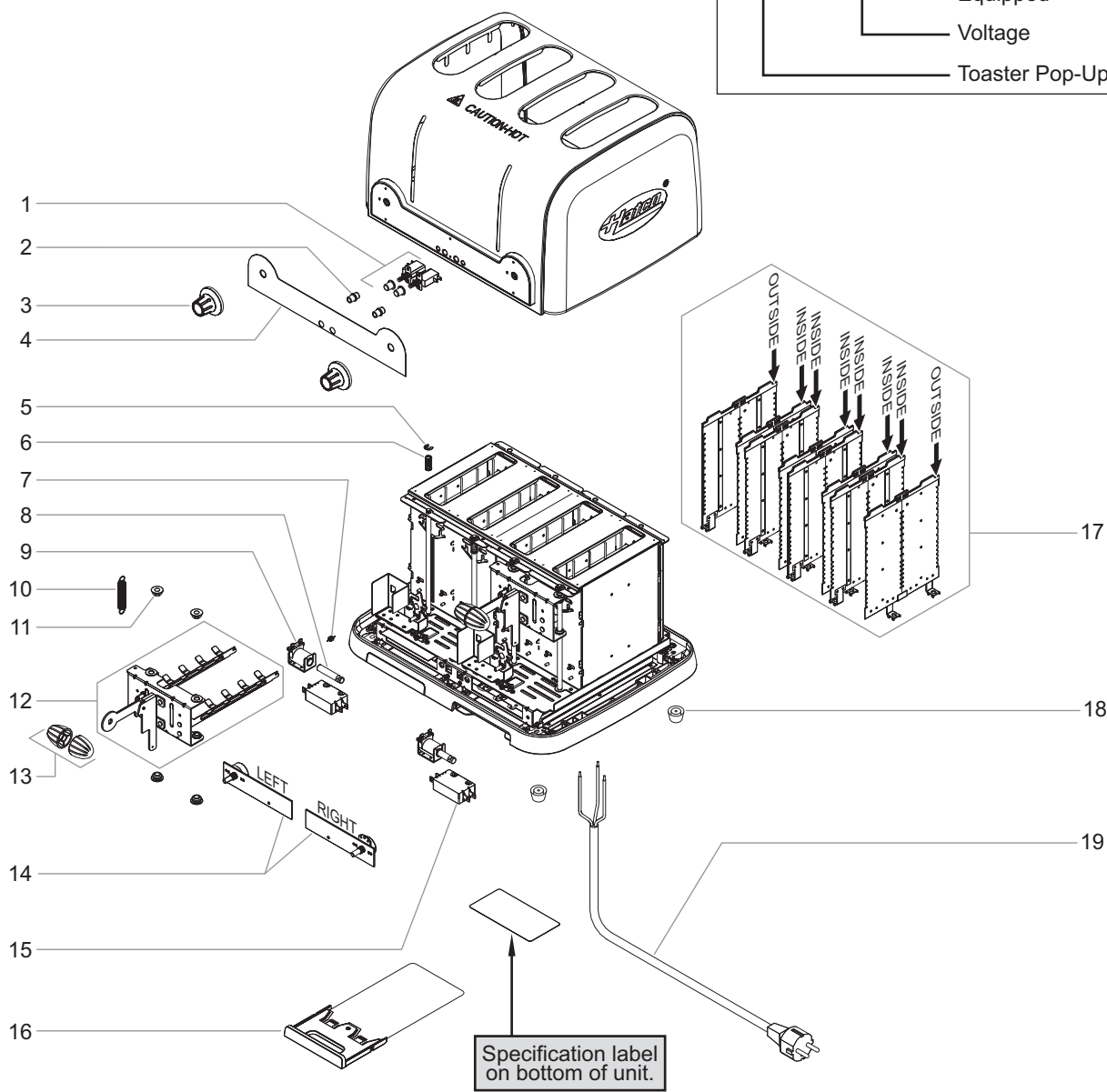
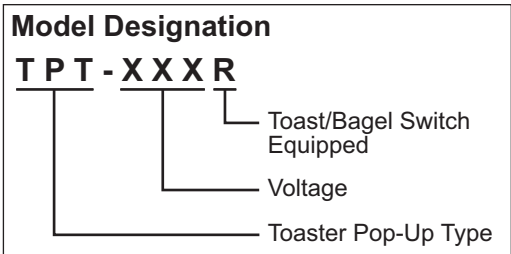

IMPORTANT! — HOW TO USE THIS SECTION

This section of the TPT Series Replacement Parts List includes part numbers for different versions/revisions of the TPT-120R and TPT-230R Model Pop-Up Toasters. Each of these versions were given a specific **Item** number— "TPT120.R01", "TPT120CA.R01", and "TPT230.R01". The **Item** number is printed on the top, right side of the specification label. The specification label is located on the bottom of the unit.

To find the correct replacement parts for a TPT-120R or TPT-230R Model Pop-Up Toaster, locate the specific **Item** number and refer to the appropriate column in the table on the next page.

Part numbers of "----" indicate the item is not available for the designated unit.

HATCO CORPORATION, MILWAUKEE, WISCONSIN, U.S.A.

MADE IN U.S.A.
Model: TPT-120R S/N: 1234610901 **Item: TPT120.R01**

	~VAC	WIRE	WATTS	Amperes	Hz
CIRCUIT 1:	120	2	1800	15.0	60

U.L. File E42639

UL LISTED 587L CLASSIFIED EPR ANSV/NSF#4

Example of a TPT-120R Specification Label

TPT-120R AND TPT-230R MODELS PARTS LIST

Item	Description	Item #s: TPT120.R01 TPT120CA.R01	Item #: TPT-230R-4	Qty.
		Part Number	Part Number	
1	Selector Switch ‡	X02.19.228.00	X02.19.228.00	2
2	Indicator Lamp	X02.30.131.00	X02.30.131.00	2
3	Knob, Color Control	X05.30.141.00	X05.30.141.00	2
4	Decal, Control Panel ‡	X07.01.365.00	X07.01.365.00	1
5	E-Ring	05.04.558.00	05.04.558.00	4
6	Damping Spring	05.08.017.00	05.08.017.00	4
7	Return Spring, Solenoid	X05.08.021.00	X05.08.021.00	2
8	Plunger, Solenoid	X02.20.362.00	X02.20.362.00	2
9	Solenoid	02.20.342.00	02.20.342.00	2
10	Carriage Spring	05.08.016.00	05.08.016.00	2
11	Shaft Bushing	05.02.028.00	05.02.028.00	8
12	Carriage Handle Assembly	X04.05.684.00	X04.05.685.00	2
13	Knob, Carriage Handle Assembly	X05.30.125.00	X05.30.125.00	2
14	Printed Circuit Board			
	Left Side (includes potentiometer)	X02.13.343.00	X02.13.352.00	1
	Right Side (includes potentiometer)	X02.13.342.00	X02.13.351.00	1
15	Micro Switch, DPDT	02.19.193.00	02.19.193.00	2
16	Crumb Tray Assembly	X04.05.682.00	X04.05.683.00	2
17	Heating Element Assembly			
	Inside †	X02.09.288.00	X02.09.290.00	6
	Outside	X02.09.283.00	X02.09.287.00	2
18	Rubber Foot	X05.30.140.00	X05.30.140.00	4
19	Power Cord and Plug			
	NEMA 5-15P *	02.18.154.00	---	1
	CEE 7/7 Schuko (shown)	---	02.18.038.00	1
	BS-1363	---	02.18.068.00	1
	AS 3112	---	02.18.104.00	1
	Wiring Diagram	10-01-782	10-01-911	

Shaded area contains information for **International models only**.

* Canadian models use P/N 02.18.089.00

† TPT-120R units with date code "0846" use inside heating element assembly X02.09.282.00.

‡ Units with date code "1235" or earlier use Selector Switch X02.19.210.00 and Control Panel Decal X07.01.357.00.

NOTE: The last four digits in a ten digit numerical serial number are the manufacturing date code.

Example: Serial number 9625060951 has a date code of "0951" which indicates the following: 0951

└─ Week Fifty-One
└─ Year 2009

HATCO POP-UP TOASTER
TPT-208, TPT-240, TPT-230-4 Models

Model Designation
TPT - XXX - 4

_____ Qty. of Toasting Slots
 _____ Voltage
 _____ Toaster Pop-Up Type

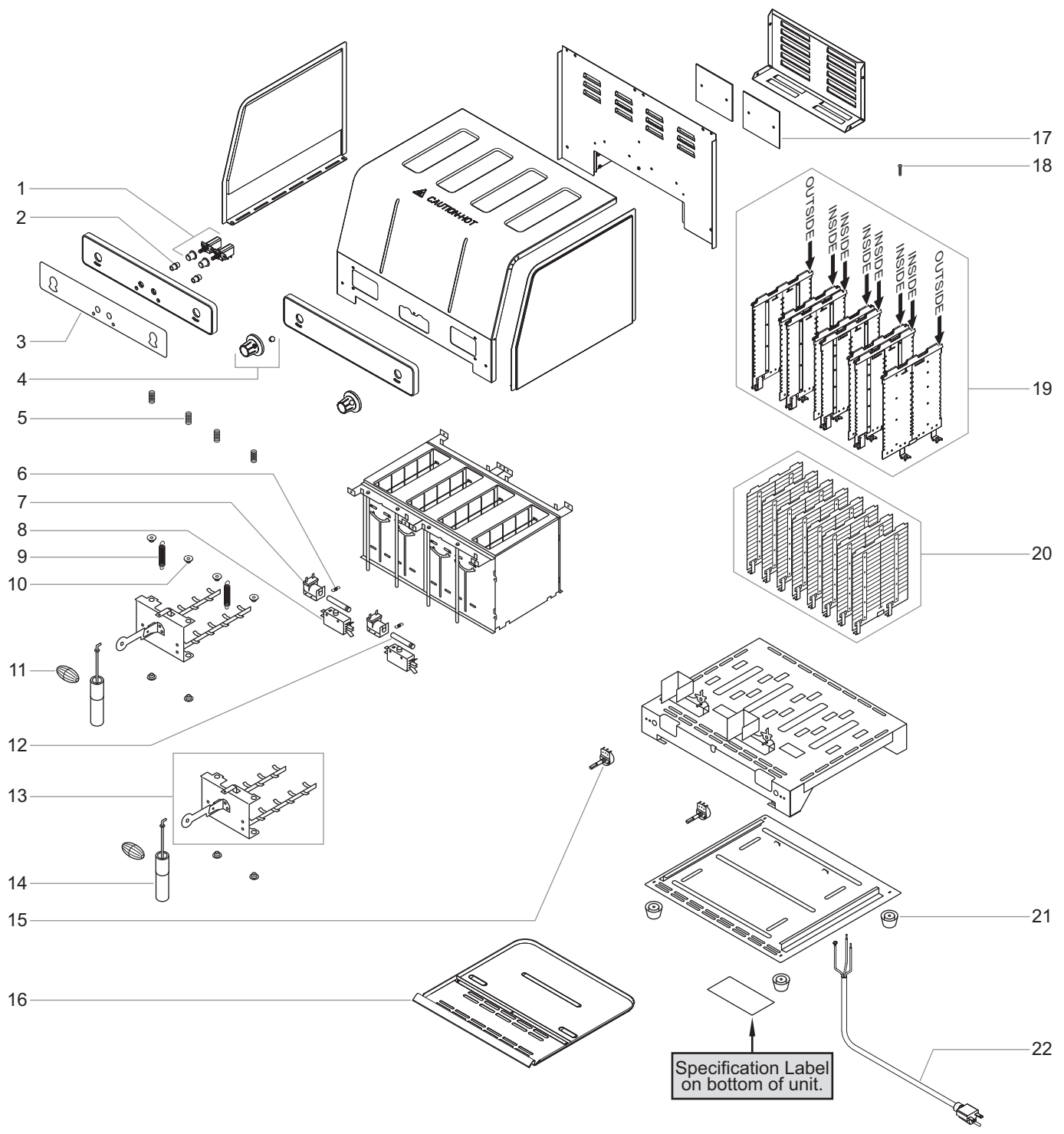

IMPORTANT! — HOW TO USE THIS SECTION

This section of the TPT Series Replacement Parts List includes part numbers for different versions/revisions of TPT-208, TPT-240, and TPT-230-4 Model Pop-Up Toasters. Each of these versions were given a specific **Item** number—"TPT208", "TPT208.R01", "TPT240", etc... The **Item** number is printed on the top, right side of the specification label. The specification label is located on the bottom of the unit.

To find the correct replacement parts for a TPT-208, TPT-240, or TPT-230-4 Model Pop-Up Toaster, locate the specific **Item** number and refer to the appropriate column in the table below and on the next page.

Part numbers of "----" indicate the item is not available for the designated unit.

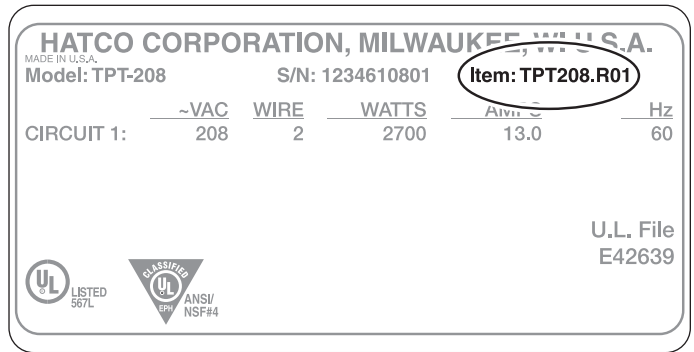

Example of a TPT-208 Specification Label

TPT-208 MODELS PARTS LIST

Item	Description	Item #s: TPT208	Item #s: TPT208.R01	Qty.
		TPT208CA	TPT208CA.R01	
		Part Number	Part Number	
1	Selector Switch	---	X02.19.228.00	2
2	Indicator Lamp	---	X02.30.131.00	2
3	Decal, Control Panel	---	X07.01.366.00	1
4	Knob, Color Control	X05.30.115.00	X05.30.141.00	2
5	Damping Spring	05.08.017.00	05.08.017.00	4
6	Return Spring, Solenoid	05.08.015.00	X05.08.021.00	2
7	Solenoid	02.20.342.00	02.20.342.00	2
8	Micro Switch, DPDT	02.19.193.00	02.19.193.00	2
9	Carriage Spring	05.08.016.00	X05.08.016.00	2
10	Shaft Bushing	05.02.028.00	05.02.028.00	8
11	Knob, Carriage Handle Assembly	R05.30.133.00	X05.30.125.00	2
12	Plunger, Solenoid	X02.20.344.00	X02.20.362.00	2
13	Carriage Handle Assembly	X04.05.548.00	X04.05.685.00	2
14	Damper Assembly	X04.05.550.00	X04.05.686.00	2
15	Potentiometer, Color Control	X02.13.335.00	X02.13.335.00	2
16	Crumb Tray Assembly	X04.05.549.00	X04.05.683.00	1
17	Printed Circuit Board	X02.01.258.00	X02.01.293.00	2
18	Screw	X05.04.561.00	---	16
19	Heating Element Assembly			
	Inside †	---	X02.09.289.00	6
	Outside	---	X02.09.285.00	2
20	Heating Element Assembly	X02.09.273.00	---	8
21	Rubber Foot Kit (includes 4 feet)	R05.30.148.04	R05.30.148.04	1
22	Power Cord and Plug			
	NEMA 6-15P (U.S.)	02.18.036.00	02.18.036.00	1
	NEMA 6-20P (Canada)	02.18.259.00	02.18.259.00	1
	Wiring Diagram	10-01-631	10-01-783	

† TPT-208 units with date code "0846" use inside heating element assembly X02.09.284.00.

NOTE: The last four digits in a ten digit numerical serial number are the manufacturing date code.

Example: Serial number 9625060951 has a date code of "0951" which indicates the following: 0951

└─ Week Fifty-One
└─ Year 2009

TPT-240 AND TPT-230-4 MODELS PARTS LIST

Item	Description	Item #: TPT240	Item #: TPT240.R01	Item #: TPT-230-4	Qty.
		Part Number	Part Number	Part Number	
1	Selector Switch	---	X02.19.228.00	---	2
2	Indicator Lamp	---	X02.30.131.00	---	2
3	Decal, Control Panel	---	X07.01.366.00	---	1
4	Knob, Color Control	X05.30.115.00	X05.30.141.00	X05.30.115.00	2
5	Damping Spring	05.08.017.00	05.08.017.00	05.08.017.00	4
6	Return Spring, Solenoid	05.08.015.00	X05.08.021.00	05.08.015.00	2
7	Solenoid	02.20.342.00	02.20.342.00	02.20.342.00	2
8	Micro Switch, DPDT	02.19.193.00	02.19.193.00	02.19.193.00	2
9	Carriage Spring	05.08.016.00	X05.08.016.00	05.08.016.00	2
10	Shaft Bushing	05.02.028.00	05.02.028.00	05.02.028.00	8
11	Knob, Carriage Handle Assembly	R05.30.133.00	X05.30.125.00	R05.30.133.00	2
12	Plunger, Solenoid	X02.20.344.00	X02.20.362.00	X02.20.344.00	2
13	Carriage Handle Assembly	X04.05.548.00	X04.05.685.00	X04.05.548.00	2
14	Damper Assembly	X04.05.550.00	X04.05.686.00	X04.05.550.00	2
15	Potentiometer, Color Control	X02.13.335.00	X02.13.335.00	X02.13.335.00	2
16	Crumb Tray Assembly	X04.05.549.00	X04.05.683.00	X04.05.549.00	1
17	Printed Circuit Board	X02.01.258.00	X02.01.293.00	X02.01.282.00	2
18	Screw	X05.04.561.00	---	X05.04.561.00	16
19	Heating Element Assembly				
	Inside †	---	X02.09.290.00	---	6
	Outside	---	X02.09.287.00	---	2
20	Heating Element Assembly	X02.09.274.00	---	X02.09.275.00	8
21	Power Cord and Plug *				
	NEMA 6-15P	02.18.036.00	02.18.036.00	---	1
	CEE 7/7 Schuko	02.18.038.00	---	02.18.038.00	1
	BS-1363	02.18.068.00	---	---	1
22	Rubber Foot (includes 4 feet)	R05.30.148.04	R05.30.148.04	R05.30.148.04	1
	Wiring Diagram	10-01-631	10-01-783	10-01-641	

Shaded area contains information for **International models only**.

* Canadian models use P/N 02.18.259.00

† TPT-240 units with date code "0846" use inside heating element assembly X02.09.286.00.

NOTE: The last four digits in a ten digit numerical serial number are the manufacturing date code.

Example: Serial number 9625060951 has a date code of "0951" which indicates the following: 0951

└─ Week Fifty-One
└─ Year 2009

Use the following information as a guide when service or parts are required on a TPT Series Pop-Up Toaster.

ATTENTION: AUTHORIZED HATCO SERVICE AGENTS

Do not perform service on any TPT Series Pop-Up Toasters that are within the one year warranty period. Contact the Hatco Service Team for instructions.

Warranty Problems — United States and Canada

The warranty on Hatco TPT Series Pop-Up Toasters is for one year from date of purchase or eighteen months from date of shipping from Hatco, whichever occurs first.

If you experience a problem with a TPT toaster during the warranty period, contact the **Hatco Service Team** at:

Telephone: 1-800-558-0607 or 414-671-6350

Fax: 1-800-690-2966 or 414-671-3976

Email: partsandservice@hatcocorp.com

When contacting Hatco for warranty service, please supply the following information:

- Model of unit
- Serial number (located on the bottom of the unit)
- Specific problem with the unit
- Date of purchase
- Name of business
- Shipping address
- Contact name and phone number

IMPORTANT NOTE: *TPT Series Pop-Up Toasters requiring service that are within the warranty period will be replaced from the factory with new or refurbished product. **In-warranty Toasters are not to be repaired in the field.***

Non-Warranty Problems

If you experience a non-warranty problem that requires assistance, please contact the nearest Authorized Hatco Service Agency.

To locate the nearest Service Agency, log onto our website at **www.hatcocorp.com** and click on Service Agency Locator, or contact the Hatco Service Team by phone.

AUTHORIZED PARTS DISTRIBUTORS • AUTORISÉS DISTRIBUTEURS DE PIÈCES

ALABAMA

Jones McLeod Appl. Svc.
Birmingham 205-251-0159

ARIZONA

Service Solutions Group
Phoenix 602-234-2443

Byassee Equipment Co.
Phoenix 602-252-0402

CALIFORNIA

Industrial Electric
Commercial Parts & Service, Inc.
Huntington Beach 714-379-7100

Chapman Appl. Service
San Diego 619-298-7106

P & D Appliance
Commercial Parts & Service, Inc.
S. San Francisco 650-635-1900

COLORADO

Hawkins Commercial Appliance
Englewood 303-781-5548

FLORIDA

Whaley Foodservice Repair
Jacksonville 904-725-7800

3Wire Nass Service Co., Inc.
Orlando 407-425-2681

B.G.S.I.
Pompano Beach 954-971-0456

Comm. Appliance Service
Tampa 813-663-0313

GEORGIA

TWC Services
Mableton 770-438-9797

Heritage Service Group
Norcross 866-388-9837

Southeastern Rest. Svc.
Norcross 770-446-6177

HAWAII

Burney's Comm. Service, Inc.
Honolulu 808-848-1466

Food Equip Parts & Service
Honolulu 808-847-4871

ILLINOIS

Parts Town
Lombard 708-865-7278

Eichenauer Elec. Service
Decatur 217-429-4229

Midwest Elec. Appl. Service
Elmhurst 630-279-8000

Cone's Repair Service
Moline 309-797-5323

INDIANA

GCS Service
Indianapolis 800-727-8710

IOWA

Goodwin Tucker Group
Des Moines 515-262-9308

KENTUCKY

Service Solutions Group
Lexington 859-254-8854

Service Solutions Group
Louisville 502-451-5411

LOUISIANA

Chandlers Parts & Service
Baton Rouge 225-272-6620

MARYLAND

Electric Motor Service
Baltimore 410-467-8080

GCS Service
Silver Spring 301-585-7550

MASSACHUSETTS

Ace Service Co., Inc.
Needham 781-449-4220

MICHIGAN

Bildons Appliance Service
Detroit 248-478-3320

Commercial Kitchen Service
Bay City 989-893-4561

Midwest Food Equip. Service
Grandville 616-261-2000

MINNESOTA

GCS Service
Minnetonka 800-822-2303
x20365

MISSOURI

General Parts
Kansas City 816-421-5400

Commercial Kitchen Services
St. Louis 314-890-0700

Kaemmerlen Parts & Service
St. Louis 314-535-2222

NEBRASKA

Anderson Electric
Omaha 402-341-1414

NEVADA

Burney's Commercial
Las Vegas 702-736-0006

Hi. Tech Commercial Service
N. Las Vegas 702-649-4616

NEW JERSEY

Jay Hill Repair
Fairfield 973-575-9145

Service Plus
Flanders 973-691-6300

NEW YORK

Acme American Repairs, Inc.
Brooklyn 718-456-6544

Alpro Service Co.
Brooklyn 718-386-2515

Appliance Installation
Buffalo 716-884-7425

Duffy's Equipment Services, Inc.
Buffalo 800-836-1014

3Wire Northern
Plattsburgh 800-634-5005

Duffy's Equipment Services, Inc.
Sauquoit 800-836-1014

J.B. Brady, Inc.
Syracuse 315-422-9271

NORTH CAROLINA

Authorized Appliance
Charlotte 704-377-4501

OHIO

Akron/Canton Comm. Svc. Inc.
Akron 330-753-6634

Service Solutions Group
Cincinnati 513-772-6600

Commercial Parts and Service
Columbus 614-221-0057

Electrical Appl. Repair Service
Brooklyn Heights 216-459-8700

E. A. Wichman Co.
Toledo 419-385-9121

OKLAHOMA

Hagar Rest. Service, Inc.
Oklahoma City 405-235-2184

Krueger, Inc.
Oklahoma City 405-528-8883

OREGON

Ron's Service, Inc.
Portland 503-624-0890

PENNSYLVANIA

Elmer Schultz Services
Philadelphia 215-627-5401

FAST Comm. Appl. Service
Philadelphia 215-288-4800

Appliance Installation & Service
Pittsburgh 412-809-0244

K & D Service Co.
Harrisburg 717-236-9039

Electric Repair Co.
Reading 610-376-5444

RHODE ISLAND

Marshall Electric Co.
Providence 401-331-1163

SOUTH CAROLINA

Whaley Foodservice Repair
Lexington 803-996-9900

TENNESSEE

Camp Electric
Memphis 901-527-7543

TEXAS

GCS Service
Fort Worth 800-433-1804

Armstrong Repair Service
Houston 713-666-7100

Cooking Equipment Specialist
Mesquite 972-686-6666

Commercial Kitchen Repair Co.
San Antonio 210-735-2811

UTAH

La Monica's Rest. Equip. Service
Murray 801-263-3221

VIRGINIA

Daubers
Norfolk 757-855-4097

Daubers
Springfield 703-866-3600

WASHINGTON

3Wire Restaurant Appliance
Seattle 800-207-3146

WISCONSIN

A.S.C., Inc.
Madison 608-246-3160

A.S.C., Inc.
Milwaukee 414-543-6460

CANADA

ALBERTA

Key Food Equipment Service
Edmonton 780-438-1690

BRITISH COLUMBIA

Key Food Equipment Service
Vancouver 604-433-4484

Key Food Equipment Service
Victoria 250-920-4888

MANITOBA

Air Rite, Inc.
Winnipeg 204-895-2300

NEW BRUNSWICK

EMR Services, Ltd.
Moncton 506-855-4228

ONTARIO

R.G. Henderson Ltd.
Toronto 416-422-5580

Choquette - CKS, Inc.
Ottawa 613-739-8458

QUÉBEC

Choquette - CKS, Inc.
Montreal 514-722-2000

Choquette - CKS, Inc.
Québec City 418-681-3944

UNITED KINGDOM

Marren Group
Northants +44(0)1933 665313

HATCO CORPORATION

P.O. Box 340500

Milwaukee, WI 53234-0500 U.S.A.

800-558-0607 414-671-6350

Parts and Service Fax 800-690-2966

International Fax 414-671-3976

partsandservice@hatcocorp.com

www.hatcocorp.com



24 Hour 7 Day Parts and Service
Assistance available in the United States
and Canada by calling 800-558-0607.