



Crathco[®]
BY GMCW[™]

Classic Bubbler[™] Premix Cold Beverage Dispensers

Operation Manual

D Series

E Series

Table of Contents

Unpacking & Installation Instructions	3
Assembly	4
Product Preparation	5
Disassembly	6
Routine Maintenance	7
Helpful Hints	7
Preventative Maintenance	8
Troubleshooting Guide	9
Parts Identification	10
MCX Mag-Drive Impeller	12

Prior authorization must be obtained from GMCW for all warranty claims.

Retain this manual for future reference.



GMCW[™]

4003 Collins Lane
Louisville, KY 40245 USA
(502) 425-4776

(800) 695-4500 (USA & Canada only)

Fax: (502) 425-4664

Email: info@gmcw.com

www.gmcw.com

0214 Form # CC-377-07
Part # 3682

SET-UP

UNPACKING

Your dispenser is packed in 2 cartons: base pack and bowl pack. Unpack base by opening bottom flaps. See Figure A.

IMPORTANT NOTES:

1. Do not leave base upside down as this can damage refrigeration system.
2. Check that all 4 rubber feet are attached to legs after removing from base pad. Check base pad or carton for missing feet and replace on legs.
3. Never lift from louvres/ventilation slots. Instead, place fingers under base plate.

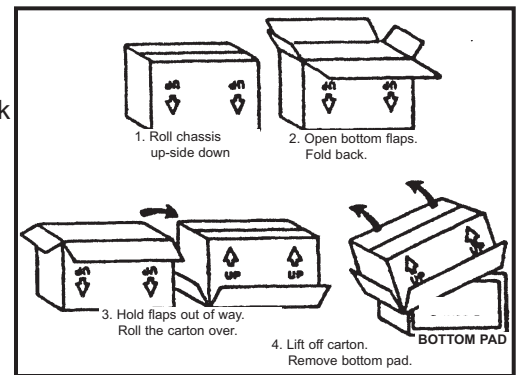

Figure A

INSTALLATION

1. Place base on counter. The appliance has to be placed in a vertical position. See Figure B.
2. Leave sufficient air space (6"(15cm)) on sides for proper airflow and efficient operation. See Figure B.
IMPORTANT: Failure to provide required airspace can damage unit.
3. Plug into properly grounded NEMA5-15R receptacle with a dedicated circuit breaker.
4. Assemble bowl parts and drain trays. See Assembly instructions (pgs 4-5). See Figure C.
5. 77°F - 86°F (25°C - 30°C) is suitable for the operation.

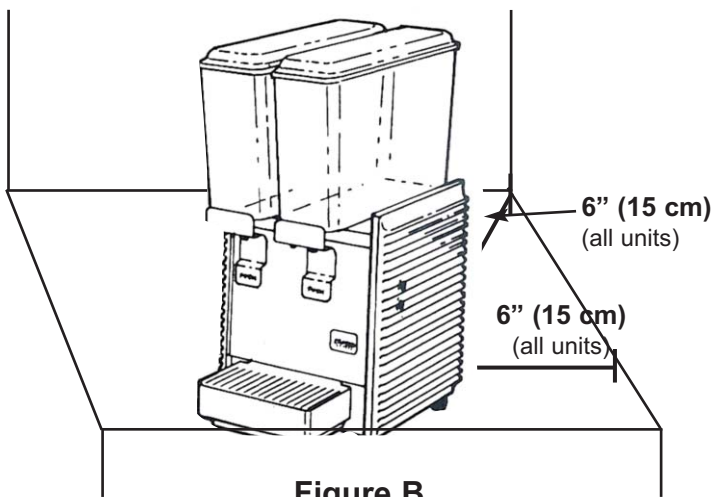

Figure B

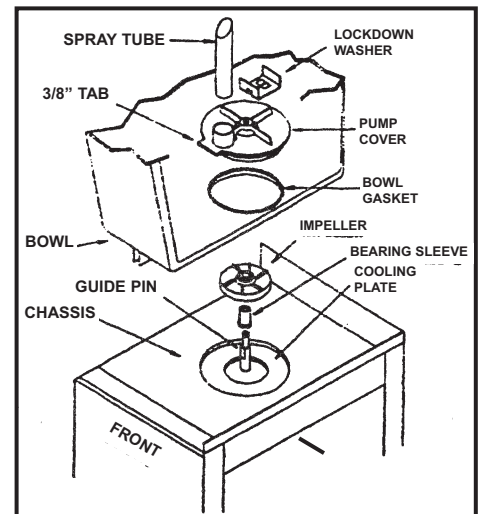

Figure C

CAUTION

This appliance is not intended for use by persons (including children) with reduced physical, sensory, or mental capabilities, or lack of experience or knowledge, unless they have been given supervision or instruction concerning use of the appliance by a person responsible for their safety.

Children should be supervised to ensure that they do not play with the appliance.

Assembly

1 PLACE BEARING SLEEVE ON GUIDE PIN

Note flat sides on outside of guide pin and on inside of bearing sleeve.

Line flat sides up until bearing sleeve slides down over guide pin and rests on the cooling plate.

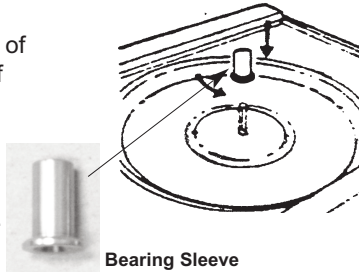

5 PLACE PUMP COVER OVER GUIDE PIN

Place the pump cover over the guide pin with the spray tube toward the front.

Note that the tab on the front of the pump cover fits between the 2 locator buttons or ridges on the bowl. Mini units - bent part of spray tube faces front of bowl.

NOTE: Use agitator cover in place of pump cover and spray tube for fresh juice, drinks that foam (iced tea or dairy products), or heavy viscous drinks.

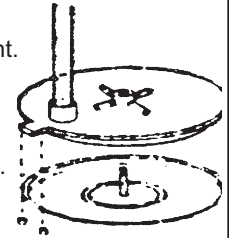

2 PLACE IMPELLER OVER BEARING SLEEVE.

Put impeller over bearing sleeve with fin side up.

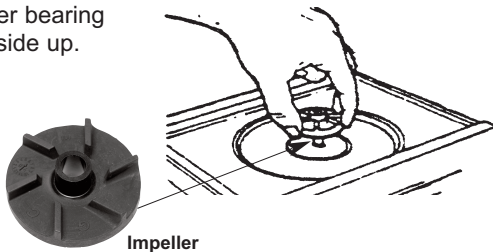

6 INSTALL LOCKDOWN WASHER OR CLAMPS

Standard Units:

- Place lockdown washer over guide pin.
- Push lockdown washer down and into locking keyway.
- Turn lockdown washer clockwise to lock into place.

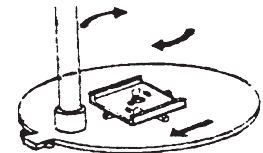

Mini Units:

- Place lockdown washer over guide pin.
- Push lockdown washer down and into locking keyway.
- Slide into locked position.

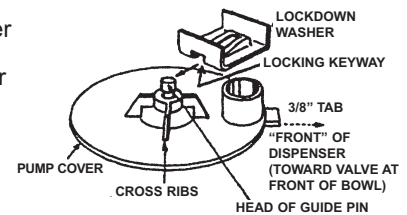

3 PLACE BOWL GASKET ON BOWL

Turn bowl upside down and place bowl gasket over the neck of the bowl. Moisten gasket with water or a thin film of lubricant.

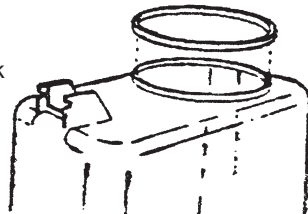

4 PUT BOWL ON BASE

Place the neck of the bowl over center of the cooling plate and with a back and forth downward motion, push bowl down into place.

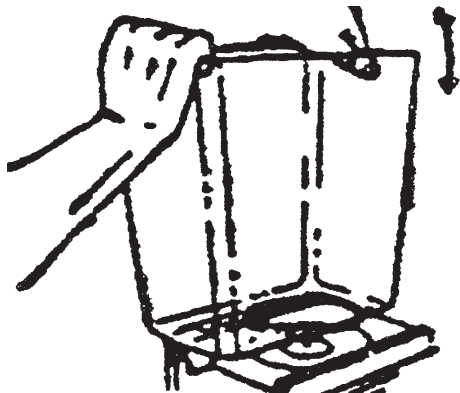

7 ASSEMBLE VALVE AND HANDLE

Place handle (C) in the two V-cuts in the front of the handle bracket (B) and push handle back.

From inside bowl, lower the valve (A) through the outlet hole, and through the hole in the handle. Release handle.

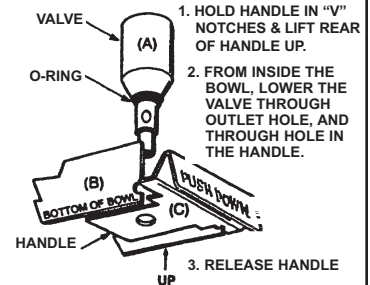

8 REPLACE DRIP PAN(S)

Place cover/grid on drip pan. Place top edge of drip pan up under lip on front panel. Lower each drip pan so that the tab goes down into the tab slot and locks pan in place.

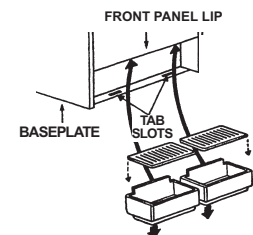

Assembly (cont.)

- 9** FILL BOWL(S) WITH PRODUCT and place lid(s) on bowl(s).
Turn spray switch on first then refrigeration.

IMPORTANT: NEVER RUN REFRIGERATION UNLESS SPRAY OR AGITATE IS ON.

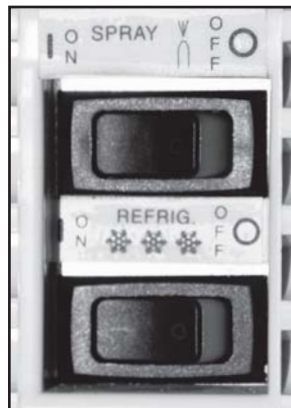

Product Preparation

- 1** BEFORE PREPARING PRODUCT:
- a) Wash hands thoroughly before handling dispenser or product.
 - b) Use only clean mixing tools to prepare product.
 - c) To ensure a safe, quality beverage use only reliable purified water or potable water source to prepare the product. Keep food or product preparation area, utensils, equipment, and surroundings clean.

- 3** POUR CONCENTRATE INTO DISPENSER then add remaining water per product label.

- 2** PREPARE PRODUCT CONCENTRATE by mixing powder with water using a wire whisk until powder is completely dissolved.



- 4** REPLACE LID ON BOWL and turn ON main power switch.

NOTE: This machine cools beverages to 41°F - 33.8°F (1°C - 5°C).

Maintenance

If the supply cord is damaged, it must be replaced by the manufacturer or a qualified service technician in order to avoid hazard.

If freezing occurs, the dispenser's power should be turned off.

This dispenser is suitable for liquid juice concentrate and powdered beverages.

DISASSEMBLY

1 DRAIN ALL BEVERAGE FROM BOWLS

- A. Remove bowl lid(s) and drip tray(s)
- B. Drain through valve then
- C. Tip unit forward, gently press spray tube back a short distance to lift the edge of the pump cover to allow remaining beverage in well to be drained through valve.

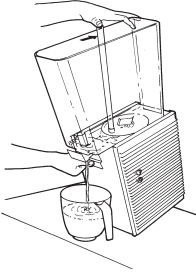

5 REMOVE BOWL AND BOWL GASKET

Twist bowl back and forth while lifting up. Bowl gasket will be around bottom of bowl.

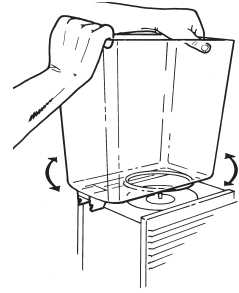

2

STANDARD & MINI UNITS:
REMOVE VALVE AND HANDLE
Lift valve. Handle drops into operator's other hand.

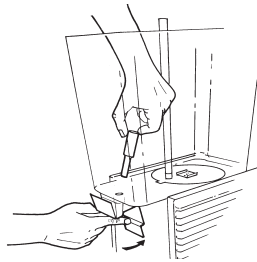

6 REMOVE IMPELLER AND BEARING SLEEVE

Remove impeller and bearing sleeve by lifting them straight up.

NOTE: Check impeller and bearing sleeves for wear. See page 8.

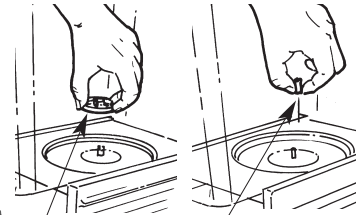

Impeller



Bearing Sleeve

3 REMOVE LOCKDOWN WASHER(S)

Standard Unit: Twist lockdown washer counterclockwise, slide to release keyway. Then lift out.

Mini Unit: Slide to release keyway, then lift out.

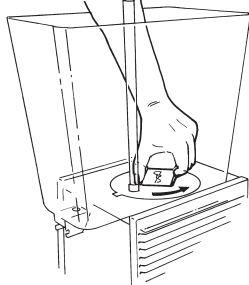

7 THOROUGHLY CLEAN ALL PARTS IN WARM WATER USING A MILD NON-ABRASIVE DETERGENT AND RINSE THOROUGHLY.

CAUTION: ABRASIVES WILL SCRATCH PLASTIC PARTS. WASH BOWL LIDS IN COOL OR LUKEWARM WATER TO AVOID LEAKS DUE TO SEALED SURFACE BEING DAMAGED.

NOTE: THE DISPENSER MUST NOT BE CLEANED WITH A WATER JET.

4 REMOVE PUMP COVER

Remove pump cover by lifting up on spray tube.

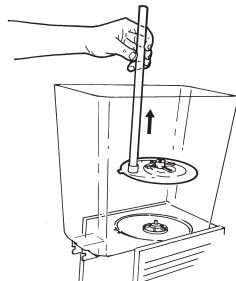

SANITIZE

Immerse parts in sanitizing solution for 1-2 minutes. Remove parts from sanitizing solution and drain. **DO NOT RINSE.** Place parts on a clean surface to air dry. Wipe the machine, condensate tray and cooling plate depression with a cloth wetted with sanitizer solution.

IMPORTANT: Never pour dry powder, crystals, or concentrate into a dry bowl. Premixing beverage in separate container is recommended. If mixing in bowl, always add water first.

ROUTINE MAINTENANCE: For all Models

Cleaning Your Dispenser

To optimize performance or when using dairy products, clean unit daily.

Regular cleaning of bowl components will result in maximum pumping efficiency, proper seating and sealing, and prevention of leaks at the valve O-Ring and bowl gasket by removing dried-on beverage solids and pulp from moving sealed parts.

1. Wash all bowl components regularly. Follow all local health codes.
* Refer to Disassembly, Cleaning, and Assembly instructions on pages 4-6.

Sanitizing Your Dispenser

* Refer to Disassembly and Assembly instructions on pages 4-6.

1. In the bowl, mix one gallon of Oxford Chemical's Disinfectant/Sanitizer Formula C or its equivalent.
2. Turn on spray motor(s) and allow sanitizer to spray around inside of bowl for a period of time as recommended by the sanitizer manufacturer. Formula C is satisfactory for this purpose when mixed in a solution of 1 liquid ounce of cleaner to 4 gallons of water. Run spray motor(s) for 60 seconds. In areas with extreme hard water, consult the local health authority.
3. Drain sanitizer **completely** and **thoroughly** during each step of the cleaning process (wash, rinse, and sanitize). Refer to tips on draining in Disassembly Guide on page 6.

HELPFUL HINTS

1. **Noisy Impeller:** Do not run impeller dry. The impeller will make a chattering sound in an empty bowl. Remove the impeller and run a small amount of water in the bowl.
2. **Valve and O-Ring:** On the first installation, if there is an after-drip, place your hand on the valve and with a slight downward pressure turn it slightly. This will help seat the o-ring so that it is properly aligned with the valve seat. If an o-ring becomes cut or worn it should be replaced. If you are pumping a product which has excessive pulp, a separate valve weight may be purchased to add extra weight so the o-ring will press down against the pulp and guarantee a positive shut-off.
3. **Valve Cap Use:** The Valve Cap (Part # 2039) insures that a tight valve seal will occur with products containing heavy pulp. The Valve Cap can be installed by placing it on top of the Valve after the Valve has been assembled into the bowl. See Figure D.
4. **High Water Marks on Bowl:** When you agitate, you may get "high water marks" as the beverage level drops. Keep the bowl as full as possible.
5. **Spray or Agitate?:** Most beverages can be sprayed. It is best not to spray iced tea, iced coffee, natural juices, or beverages that foam (whipped drinks). A special agitator plate (included) is used in place of a pump cover and spray tube to promote circulation.
6. **Proper Cooling:** Always keep spray switch on when refrigeration switch is on. A unit must spray or agitate to cool. Failure to do this will cause impeller to lock-up. The dispenser is designed to run 24 hours a day. Keep both spray and agitate on when beverage is in the bowls.
7. **Condensation:** Condensation on the bowls and lids is natural, cool, and refreshing. The amount of condensation is affected by humidity. Condensation will run down the front panel into the drip tray. Remember to occasionally empty the drip trays.
8. **Single Bowl Operation:** If you find it necessary to run your dispenser with only one bowl containing beverage, put one half (1/2) cup of water in the unused cooling plate depression(s) for best one-bowl operation and efficiency.

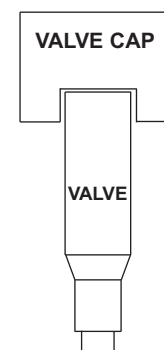

Figure D

PREVENTATIVE MAINTENANCE

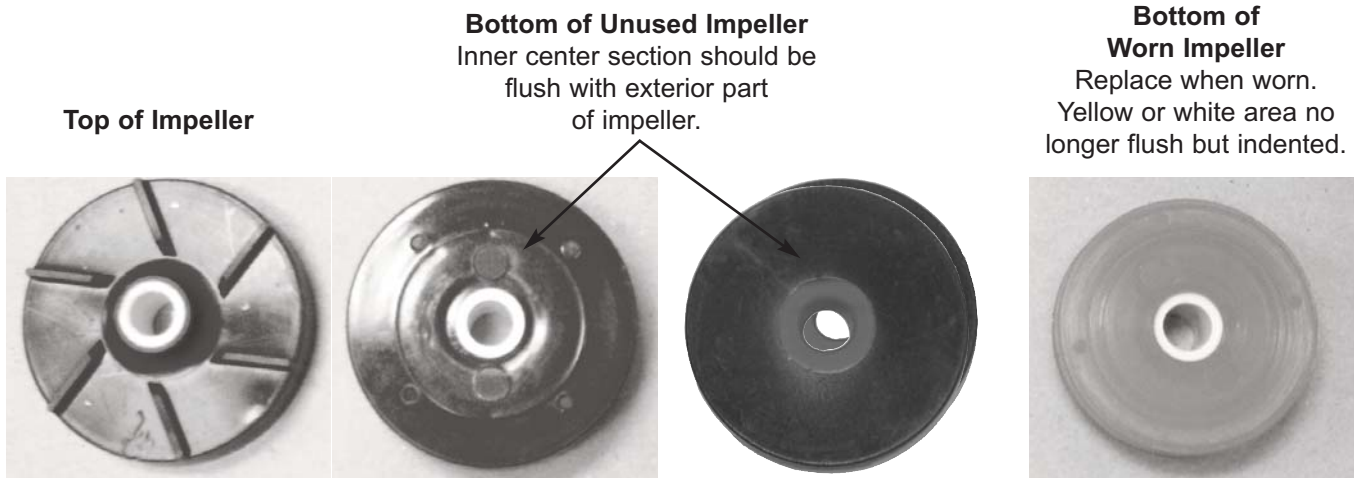

Figure E

- 1) Wash all bowl components regularly.
- 2) Wash impeller and bearing sleeve individually and check for wear.
 - a) Check for wear on bearing sleeve (flange should be 1.77mm thick - thickness of penny or quarter). (Figure F)
 - b) Check for wear on impeller (inner white center section should be flush with colored part of impeller). (Figure E)
 - c) If bearing sleeve or impeller do not spin freely or are worn - replace them. (Figure I)
 - d) Worn parts can cause personal injury, impair cooling and can damage machine. (Figure G & H)
- 3) Check valve o-rings and bowl gaskets for wear or damage - replace every 6 months or as needed.
- 4) Every 6 months or more often if needed: unplug unit, remove panels, clean condenser and interior. (Remove dust and lint from fins with a soft brush and vacuum.)
- 5) For further information, visit www.gmcw.com or call +1-502-425-4776.



Figure F

New bearing sleeve
flange (approx. 1.77mm - thickness of penny or quarter)



Figure G

Worn bearing sleeve (replace when worn to approx. 1mm or 1/2 thickness of penny or quarter).
worn flange



Figure H

Bearing sleeve with flange missing is extremely worn. Discard immediately.
CAUTION: Handle with care. Sharp edges may cause personal injury or damage to machine.



Figure I

Bearing sleeve and impeller should spin freely when held like this. If parts do not spin freely or are worn, unit will not cool properly and worn parts may damage machine.

Part #s for Preventative Maintenance	
Description	Part #
Bearing Sleeve (all units except D112)	3220
Large Blue Impeller (D & WD model)	1161
Small Red Impeller (E model)	1008
Universal Impeller (all models)	3587
Valve O-ring	1012
Bowl Gasket - for D, WD models 5 gallon (or 3 gallon) bowl	1013
Bowl Gasket for E model and/or 9 liter bowl	2010
Bowl Gasket for 12 gallon SuperBowls (D112)	1150
Bearing Sleeve for 12 gallon Super Bowl (D112)	1983



Universal Impeller (Part # 3587)

TROUBLESHOOTING GUIDE

PROBLEM	POSSIBLE CAUSE	SOLUTION
No or partial Refrigeration: Compressor Runs NOTE: Unit must spray or agitate properly to obtain cooling	<ul style="list-style-type: none"> • Condenser clogged with dust or lint • Unit not properly spraying or agitating • Faulty fan motor • Loss of refrigerant 	<ul style="list-style-type: none"> • Unplug unit, remove panels and clean out all lint and dust from condenser and inside machine. Use vacuum cleaner or bottle brush. • See "Problem" - "No Spray or Agitation" • Replace motor (call for service) • Call for service
No Refrigeration: Compressor Does Not Run		<ul style="list-style-type: none"> • Call for service
No Spray or Agitation: Spray Motor Runs Chattering Impeller	<ul style="list-style-type: none"> • Impeller does not spin; check for worn bearing sleeve and/or impeller (see page 5) • Impeller chatters and/or does not spin properly 	<ul style="list-style-type: none"> • Replace sleeve and/or impeller if worn. • If using a dairy based product, make sure you are using the correct impeller (blue or red with "M" on bottom or a black Universal Impeller) • If not worn, clean impeller and bearing sleeve. Impeller must spin freely on bearing sleeve to spray and refrigerate properly. • Raise drive magnet higher on motor shaft, but not high enough to rub. (Call for service or see service manual)
No Spray: Spray Motor Does Not Run		<ul style="list-style-type: none"> • Call for service
Leaky Bowl	<ul style="list-style-type: none"> • Gasket improperly installed • Worn or nicked bowl gasket 	<ul style="list-style-type: none"> • Reinstall gasket. Check directions for bowl assembly. • Replace gasket
Leaky Valve	<ul style="list-style-type: none"> • Foreign particles on valve, o-ring or valve stem • Nicked or cut o-ring • O-ring twisted so will not seat uniformly 	<ul style="list-style-type: none"> • Clean valve and o-ring • Replace o-ring • Remove and remount
Noisy Unit	<ul style="list-style-type: none"> • Worn bearings in either fan motor or spray motor(s) • Bent fan blade 	<ul style="list-style-type: none"> • Replace motor(s) (call for service) • Unplug unit and re-bend fan blade to correct alignment

If you still need help, call an authorized service center in your area or call GMCW's Technical Service Department. You can reach Technical Service at (800) 695-4500 (USA & Canada only) or 1-502-425-4776 Monday-Friday, 8:00 AM-6:00 PM Eastern Standard Time. Please have the model and serial number ready so that accurate information can be given. Prior authorization must be obtained from GMCW's Technical Service Department for all warranty claims.

STANDARD BOWL ASSEMBLY PARTS

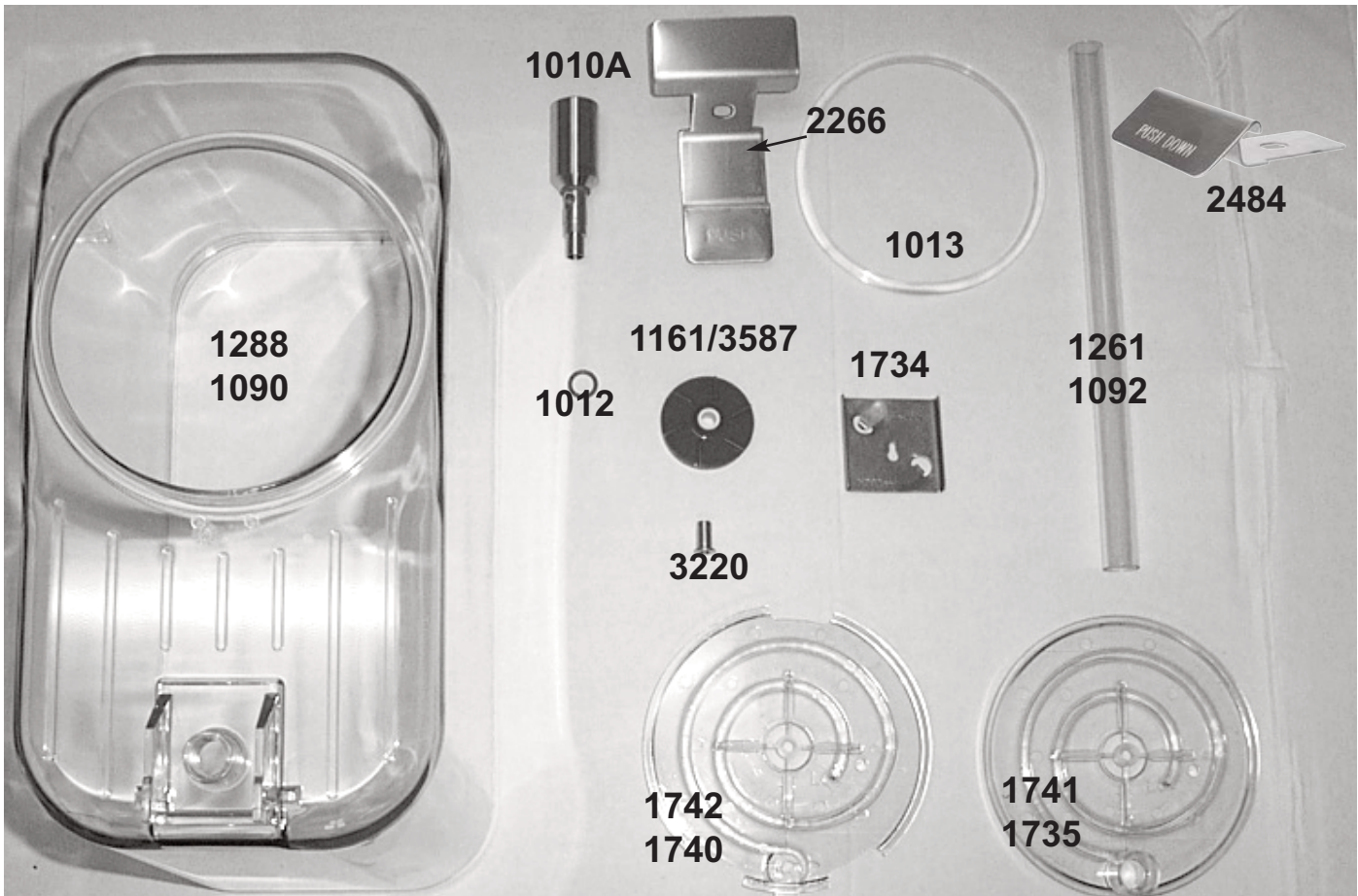

Part #	Description	Models Used On
1010A	Dispense Valve w/ O-ring	All standard (non-whipper)
1012	O-ring for Dispense Valve	All
1013	Standard Bowl Gasket	All D15, D25, D35, HD and WD models (for 5 & 3 gallon bowls)
1090	3 Gal. Bowl	All D15, D25, D35, HD and WD models
1092	3 Gal. Bowl Spray Tube	All D15, D25, D35, HD and WD models w/ 3 gal. bowls
1161	Standard Bowl Impeller (blue)	All D, HD and WD models
3587	Universal Impeller (black)	All models
1261	5 Gal. Bowl Spray Tube	All D15, D25, D35, HD and WD models w/ 5 gal. bowls
1288	5 Gal. Bowl	All D15, D25, D35, HD and WD models
1734	Washer, Lockdown	All D15, D25, D35, HD and WD models
1735	Standard Bowl Pump Cover for Red (p/n 1008) or Black (p/n 3587) Impeller (use with spray tube)	All D15, D25, D35, HD and WD models
1740	Agitator for use with Red (p/n 1008) or Black (p/n 3587) Impeller	All D15, D25, D35, HD and WD models
1741	Standard Bowl Pump Cover for Blue Impeller (use with spray tube)	All D15, D25, D35, HD and WD models
1742	Standard Bowl Agitator for Blue Impeller (for iced tea, viscous products, or orange juice)	All D15, D25, D35, HD and WD models
2231	Plastic Drip Tray	D15-4, D25-4, D35-4, E27-4, D112-4, HD & WD models
2232	Plastic Drip Tray Grid	D15-4, D25-4, D35-4, E27-4, D112-4, HD & WD models
2240	Standard Bowl Lid	All D15, D25, D35 and WD models (Do not use on HD models)
1116	Bowl Lid for Heated Units	HD (heated models)
2243	Stainless Steel Drip Tray	D15-3, D25-3, D35-3, D112-3 and HD-3 models
2266	Dispense Valve Handle	All standard (non-whipper)
2484	Non-Contact Handle	All standard (non-whipper)
2305	Stainless Steel Drip Tray Grid	D15-3, D25-3, D35-3, D112-3 and HD-3 models
3220	Bearing Sleeve	All

MINI BOWL ASSEMBLY PARTS

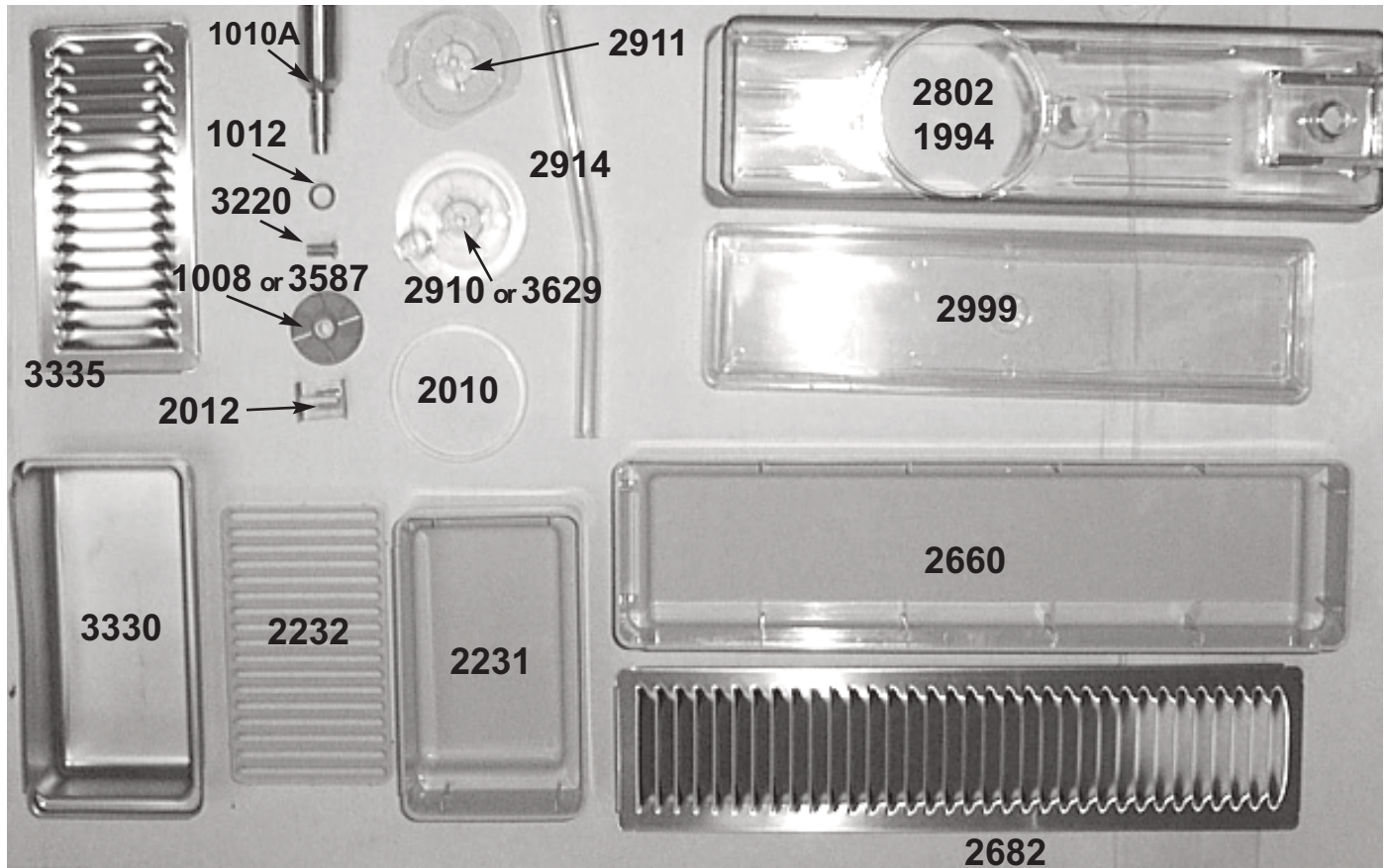

Part #	Description
1008	Mini Bowl Impeller (red)
1010A	Dispense Valve w/ O-ring
1012	Dispense Valve O-ring
1994	7 Liter Bowl
2010	Mini Bowl Gasket
2012	Mini Bowl Lock Washer
2231	Mini Twin Plastic Drip Tray
2232	Mini Twin Plastic Drip Tray Grid
2266	Dispense Valve Handle (pictured w/ std bowl assembly photo)
2484	Non-Contact Handle (pictured w/ std bowl assembly photo)
2660	Mini Quad Drip Tray (Plastic)
2682	Mini Quad Drip Tray Grid
2802	Standard 9 Liter Bowl
2910	Mini Bowl Pump Cover (use w/ spray tube) use w/ red impeller (p/n 1008)
2911	Mini Bowl Agitator (use with iced tea, orange juice, and viscous products)
2914	9 Ltr. Mini Bowl Spray Tube
2999	Cover for 9L Bowl
3220	Bearing Sleeve
3330	Stainless Steel Drip Tray, E27, E47
3335	Stainless Steel Drip Tray Grid, E27, E47
3587	Universal Impeller (black)
3629	Mini Bowl Pump Cover - use with black impeller (p/n 3587)

MCX Mag-Drive™ Impeller

by Crathco®

Purely the Best

Features:

Proprietary one-piece design using advanced, magnetic compound material...

- Smooth surfaces assure complete sanitizing
- High performance nylon bearing - harder material for longer life
- More powerful and efficient action
- One size fits all - use in all types of beverages and all models
- Common parts for lower inventory
- Crathco Bubblers™ -
 - * Built simple
 - * Built stronger
 - * Built to last



Specifications and Use:

- Part #: 3587
- Recommended for use in all models

Bowl size	Recommended Pump Cover (when spraying)	Recommended Agitator (when not spraying)
9L - 2.4 gal. (or 7L)	part # 2910	part # 2911
18L - 5 gal. (or 3 gal.)	part # 1735 (1741 may also be used on 60 Hz units)	part # 1740 (1742 may also be used on 60 Hz units)



Tel +1-502-425-4776 • Fax +1-502-425-4664 • 1-800-695-4500 • www.gmcw.com • email: info@gmcw.com