



DESIGNED SMART. BUILT SOLID.®

HORIZONTAL CONVEYOR TOASTER

MODEL:
AT Express



OWNERS MANUAL

2M-93300045 Rev. D (12-23)



WARNING: California Residents Only. This product can expose you to chemicals including chromium which is known to the State of California to cause cancer and birth defects or other reproductive harm. For more information go to www.P65Warnings.ca.gov.



FOR YOUR SAFETY: Do not store or use gasoline or other flammable vapors and liquids in the vicinity of this or any other appliance.



WARNING: Improper installation, operation, service or maintenance can cause property damage, injury or death. Read and understand these instructions thoroughly before positioning, installing, maintaining or servicing this equipment.



Initial heating of appliance may generate smoke or fumes and must be done in a well ventilated area. Overexposure to smoke or fumes may cause nausea or dizziness.

APW Wyott® cooking equipment has been engineered to provide you with year-round dependable service when used according to the instructions in this manual and standard commercial kitchen practices.

This manual includes material related to installation, use, cleaning, and care. Exploded view[s], as well as any available parts list[s] and wiring diagram[s] pertaining to the unit[s] covered by this manual are also included.

This manual must be read and understood by all persons using or installing this appliance. Contact your APW Wyott dealer if you have any questions concerning installation, use, or maintenance of this equipment.

DO NOT DISCARD THIS MANUAL.

APW Wyott Food Service Equipment Company

265 Hobson St. • Smithville, TN 37166

(800) 527-2100 • apwwyott.com

SERVICE INFORMATION

IF A SHORTAGE OR A PROBLEM, CALL - in the USA: (800) 527-2100

PLEASE FOLLOW THESE INSTRUCTIONS:

A. ON CALLS YOU WILL NEED TO GIVE THE FOLLOWING INFORMATION.

1. Name and title of person calling.
2. Phone number of person calling.
3. Business name.
4. Street address.
5. City, State, Zip.
6. Model Number (from serial plate).
7. Serial Number (from serial plate).
8. Date purchased (if serial number indicates date of manufacture is over 13 months old you will be asked to supply proof of purchase)
9. Purchased from.

B. FOR SHORTAGE - SUPPLY THE ABOVE INFORMATION AND FULLY EXPLAIN WHAT IS MISSING. It will be sent immediately - prepaid via UPS or equivalent. (Next Day Air or Priority shipments available at customer's expense).

C. FOR EQUIPMENT PROBLEM - IF WITHIN ONE YEAR FROM DATE OF PURCHASE, THIS UNIT FAILS TO FUNCTION, YOU ARE ENTITLED TO - YOUR CHOICE OF 1, 2, OR 3.

APW Wyott will replace the unit.

When calling the factory, besides the above information you will need Electrical Characteristics, voltage and phase; describe the problems the best you can. The factory will require a *Visa or Master Card number and expiration date of same to assure return and/ or validity of condition. Upon validation of credit card information, factory will strive to ship a replacement unit the same day if call is received before 3:00 p.m. Central Time or the next day if later. The replacement unit will be shipped prepaid regular UPS or equivalent. If requested Next Day Air or Priority, shipment will be made at customer's expense. Upon receipt it is the customer's responsibility to unpack the new unit taking care to preserve the packaging. Repack the unit being replaced in the same container using caution to pack properly and return this unit to the factory following the instructions supplied. Factory will supply return label and UPS call tag, both must be used. If original unit is returned within 30 days and is as represented the credit card validation will be canceled.

*IMPORTANT - If factory does not receive the unit to be returned within 30 days, the unit will be billed to the credit card number supplied. If the returned unit is not as represented - i.e. out of warranty, customer abuse, then it will be billed to the credit card number supplied. In these cases, the person calling in the problem will be contacted and if applicable the returned unit if charged for will be returned to the original owner if requested.

1. **You may take this unit to the APW Wyott Authorized Service Distributor. List of same is included with each product. If the problem is covered under warranty the unit will be repaired at no cost to you. If the Authorized Agency cannot repair same within a reasonable time while you wait, it will be returned to you prepaid, via UPS.**
2. **You can request the Authorized Service Distributor to service the equipment on site. If problem is covered under the warranty the parts and labor will be billed to the factory, the mileage and travel time will be responsibility of the owner.**

THIS REPLACEMENT WARRANTY IS ONLY AVAILABLE ON SELECTED PRODUCTS SHIPPED WITHIN THE CONTINENTAL USA, ALASKA, HAWAII AND CANADA. AS WITH MOST WARRANTIES - WARRANTY IS ONLY VALID TO THE ORIGINAL END-USER/OWNER.

INSTRUCTIONS AND PROCEDURES MUST BE FOLLOWED OR THE WARRANTY IS VOID.

























TABLE OF CONTENTS































ITEM	PAGE	ITEM	PAGE
Safety Precautions	2	Cleaning Instructions	6
Important Safety Instructions	3	Warranty Procedure	6
General Information	4	Troubleshooting	6
Installation Instructions	4	Replacement Parts List	8
Specifications	5	Wiring Diagram	10
Operation Instructions	5	Warranty	12

SAFETY PRECAUTIONS

Before installing and operating this equipment be sure everyone involved in its operation is fully trained and is aware of all precautions. Accidents & problems can result by a failure to follow fundamental rules and precautions.

The following words and symbols, found in this manual, alert you to hazards to the operator, service personnel or the equipment. The words are defined as follows:

	DANGER: This symbol warns of imminent hazard which will result in serious injury or death.	
	WARNING: This symbol refers to a potential hazard or unsafe practice, which could result in serious injury or death.	
	CAUTION: This symbol refers to a potential hazard or unsafe practice, which may result in or moderate injury or product or property damage.	
	NOTICE: This symbol refers to information that needs special attention or must be fully understood even though not dangerous.	
	IMPORTANT: Read the following important safety instructions to avoid personal injury or death, and to avoid damage to the equipment or property.	
	WARNING: Do not allow untrained personnel to operate the toaster.	
	NOTICE: Do not use toppings (butter, etc.) on product as product is inverted during normal operation.	
	WARNING: To avoid any injury, turn the power switch off at the fuse disconnect switch/circuit breaker or unplug the unit from the power source and allow to cool completely before performing any maintenance or cleaning.	
	WARNING: An earthing cable must connect the appliance to all other units in the complete installation and from there to an independent earth connection.	
	WARNING: Unit is not waterproof. Do not submerge in water. Do not operate if it has been submerged in water. Do not clean the unit with a water jet.	
	WARNING: To avoid electrical shock, always unplug the unit before performing cleaning or maintenance.	
	WARNING: To avoid electrical shock or personal injury, do not steam clean or use excessive water on the unit.	

	NOTICE: Operating toaster without legs invalidates any warranty claims.	
	WARNING: Operating the toaster without the Reflector Tray reduces the toasting capabilities.	
	NOTICE: Neglecting to keep fan opening clean could result in toaster failure.	
	WARNING: APW Wyott toasters are designed, built, and sold for commercial use. If positioned where the general public can use them, make sure that all cautions, warnings, and operating instructions are clearly posted near each unit to insure proper operation, reduce the chance of personal injury and/or equipment damage.	
	WARNING: Plug unit into a properly grounded electrical outlet of the correct voltage, size and plug configuration. If the plug and receptacle do not match, contact a qualified electrician to determine the proper voltage and size and install the proper electrical outlet.	
	WARNING: For safe and proper operation, the unit must be located a reasonable distance from combustible walls and materials. If safe distances are not maintained, discoloration or combustion could occur.	
	WARNING: To avoid electrical shock or personal injury, do not steam clean or use excessive water on the unit.	
	WARNING: If service is required on this unit, contact your authorized APW Wyott Service Agent, or contact the APW Wyott Service Department directly at (800) 527-2100.	
	WARNING: This product has no “user” serviceable parts. To avoid damage to the unit or injury to personnel, use only Authorized APW Wyott Service Agents and genuine APW Wyott Parts when service is required.	
	WARNING: Genuine APW Wyott Replacement Parts are specified to operate safely in the environments in which they are used. Some aftermarket or generic replacement parts do not have the characteristics that will allow them to operate safely in APW Wyott equipment. It is essential to use APW Wyott Replacement Parts when repairing APW Wyott equipment. Failure to use APW Wyott Replacement Parts may subject operators of the equipment to hazardous electrical voltage, resulting in electrical shock or burn.	
	CAUTION: Some exterior surfaces on the unit will get hot. Use caution when touching these areas to avoid injury.	
	CAUTION: Locate the unit at the proper counter height, in an area that is convenient for use. The location should be level to prevent the unit or its contents from accidentally falling, and strong enough to support the weight of the unit and food.	
	WARNING: In Europe, appliance must be connected by an earthing cable to all other units in the complete installation and thence to an independent earth connection in compliance with EN 60335-1 and/or local codes.	
	CAUTION: Use only non-abrasive cleaners. Abrasive cleaners could scratch the finish of your unit, marring its appearance and making it susceptible to dirt accumulation.	
	WARNING: Failure to provide clearances will cause unit failure and invalidate warranty claims (see installation instructions).	

GENERAL INFORMATION

- I. Consult the rating label for model and serial number. Write this information below before proceeding: A. Model # _____ B. Serial # _____
 - II. Overall Dimensions w/Wire Feeder - 13.27" H (33.70cm) x 14.72" W (37.39 cm) x 17.99"D (45.69cm)
 - III. Product Opening - 1.5" H (3.8cm) x 10.50" W (26.7cm)
 - IV. Productivity (per hour) - results will vary depending on line voltage and bread dryness.
 - V. Electrical Requirements
 - A. Single phase, 120 volts, 1800 watts, 15 amps.
 - B. Cordset configuration
 1. Each toaster is equipped with a three-wire grounded cordset and standard three-prong plug.
 2. In the United States, a four foot cordset with NEMA5-15P plug.
 3. In Canada, a six foot cordset with NEMA5-20P plug.
- Net/Shipping Weight - 28lb.(12.7kg) /33lb.(14.97kg)

INSTALLATION INSTRUCTIONS

- I. Check Contents - refer to Figure 1, account for the following parts:
 - A. Toast Drawer - shipped in place
 - B. Reflector Tray - shipped in place
 - C. Wire Feeder - inside Reflector Tray
 - D. Instruction Manual - shipped loose
- II. Position Wire Feeder - refer to Figure 2

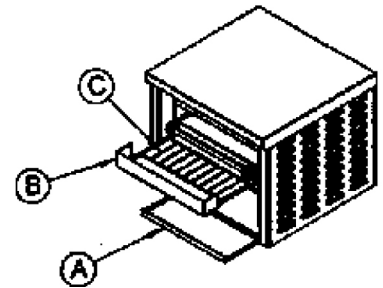

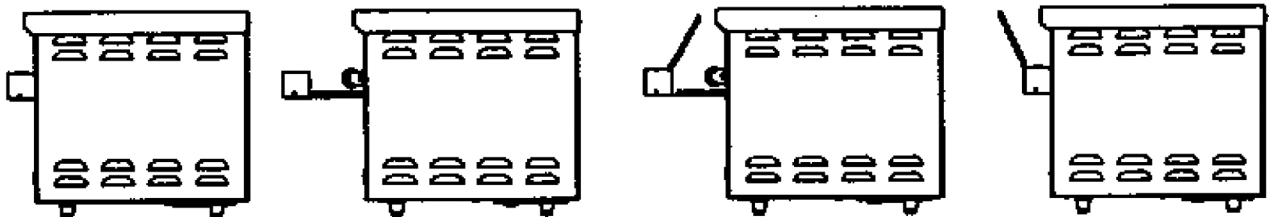

- A. Pull out Reflector Tray
- B. Rotate Wire Feeder
- C. Slide Reflector Tray back
- D. **WARNING:** Operating the toaster without the Reflector Tray reduces toasting capabilities.



III. Toaster Placement

- A. Locate the toaster near a grounded receptacle of the proper configuration (see below). Plug the cordset directly into receptacle (DO NOT USE AN EXTENSION CORD).
 - 1. In the United States, NEMA5-15R.
 - 2. In Canada, NEMA5-20R.
- B. Place the toaster on a flat surface providing the following minimum clearances:
 - 1. Base = one inch (provided with legs installed).
 - 2. Side and back walls = two inch
 - 3. Overhead = Enough space to allow adequate heat displacement.
 - 4. **WARNING:** Failure to provide these clearances will cause unit failure and invalidate warranty claims.
- C. Position toaster where customers will not contact any surface labeled "CAUTION HOT".

 **NOTICE:** Do not operate the toaster with the legs removed. 

SPECIFICATIONS

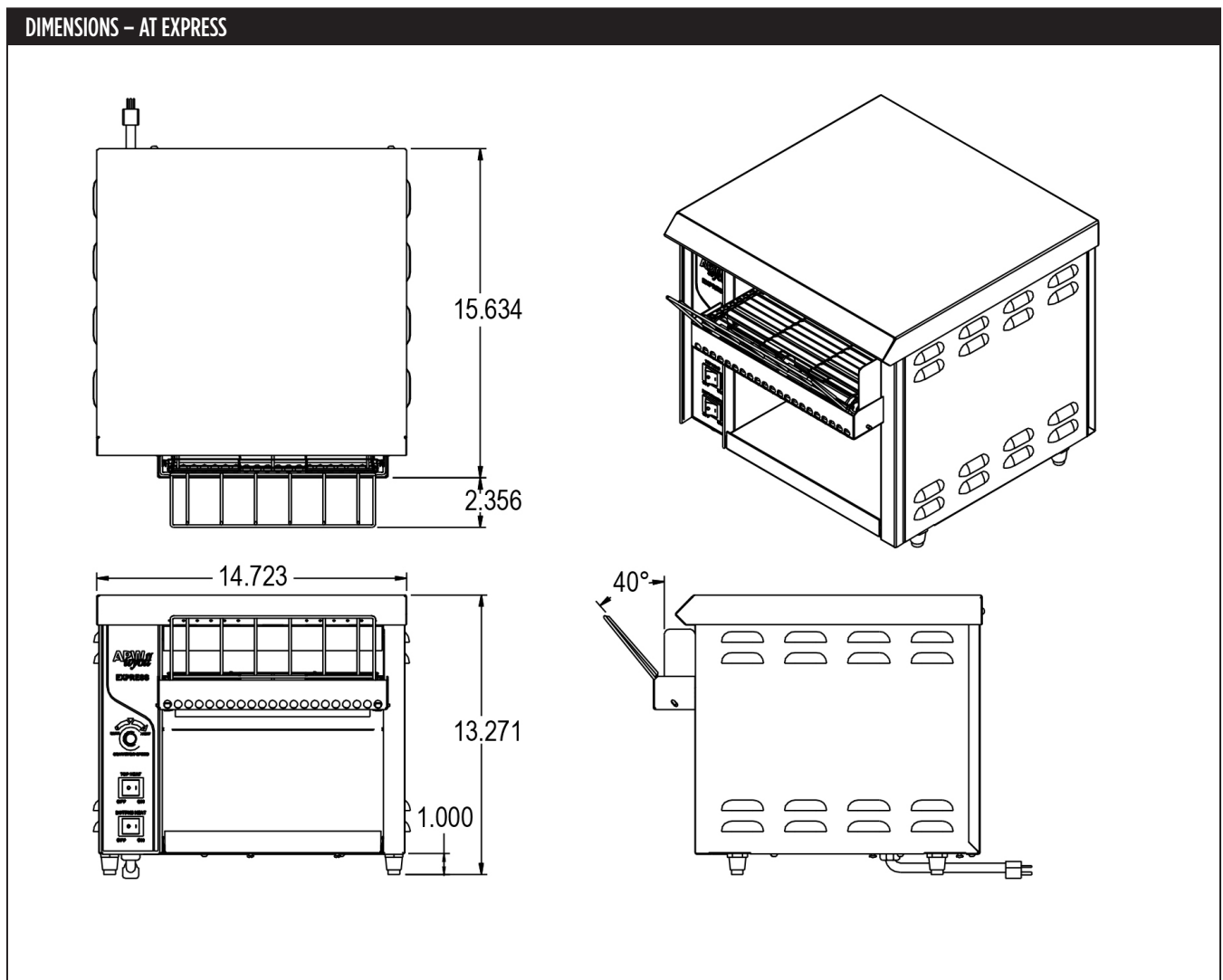

OPERATION INSTRUCTIONS

- I. Preparation
 - A. Clean toaster thoroughly before first use (See cleaning instructions).
 - B. Controls Familiarity
 1. Top Heat Switch: Operates top elements and conveyor.
 2. Bottom Heat Switch: Operates bottom element and conveyor.
 - C. Warm-up time: Allow five (5) minutes.
- II. Normal Use
 - A. Loading Product
 1. Place product on Wire Feeder. The conveyor will automatically draw product through the toaster at a speed determined by conveyor speed control.
 - B. Toasting Darkness: determined by conveyor speed.
 1. Darkest toasting - set conveyor speed control to one (1).
 2. Lightest toasting - set conveyor speed control to ten (10).
 3. Other factors affecting toasting darkness.
 - a) Product moistness - moister product requires slower speeds
 - b) Sugar content in product - product with more sugar requires slower speeds
 - c) Product Temperature - cooler product requires slower speeds
 4. For best results, use day old bread stored room temperature.

CLEANING INSTRUCTIONS

- I. Daily Cleaning
 - A. With toaster off and cool, turn toaster on and set conveyor speed to four.
 - B. Using a plastic abrasive pad, wipe the conveyor belt in a back and forth motion (side-to-side) motion to remove baked-on product. Wipe the conveyor belt in the same manner with a hot, damp cloth.
 - C. Turn off toaster.
 - D. Slide the reflector/crumb tray out of toaster by pulling forward. Dispose of crumbs and wash tray in hot, soapy water. Dry tray and place back in toaster.
 - E. Remove toast drawer from toaster by sliding out and lifting up. Dispose of crumbs and wash drawer in hot, soapy water. Wipe crumbs from inside the toaster with a hot, damp cloth. Dry drawer and place back in toaster.
 - F. Wipe the exterior surfaces of the toaster with a hot, damp cloth.
- II. Periodic Cleaning
 - A. Conveyor Belt
 1. Remove conveyor belt from toaster.
 2. Use pliers to bend a link to the inside until the hook clears the link above.
 3. Repeat on other side.
 4. Pull the loosened links together and slide through center of belt link.
 5. Clean belt thoroughly (See item 2 under "daily cleaning").
 6. Install conveyor belt by reversing order of steps noted above (See item 1).
 - B. Cooling Intake Fan
 1. Unplug and lay toaster on side.
 2. Brush dirt and debris from fan opening and guard.
 3. WARNING: Neglecting to keep fan opening clean could result in toaster failure.

WARRANTY PROCEDURE

If warranty service is needed on your AT EXPRESS™, follow these steps:

- I. Identify the model and serial number from the rating label on your toaster.
- II. Consult the enclosed directory, find the service agency nearest you, call the number listed or the 24- hour toll free service hot line, (800) 527-2100. If there is not a service agency listed for your area, the parts distributor will provide service for your toaster.
- III. To order parts consult the enclosed directory. The parts distributor is listed at the beginning of each state listing. The parts distributors have a complete stock of parts for your toaster.

TROUBLESHOOTING

- I. Always ask and check the following:
 - A. Is the unit connected to a live power source?
 - B. Check the circuit breaker.
 - C. Is power switch on?
 - D. Is the unit operating on proper voltage? (see rating label)
- II. If problems exist after checking the above, check the chart below.
- III. If any service is needed (*italicized items*), call an APW Wyott authorized service agency. All service should be performed by an APW Wyott authorized service agency.

TROUBLESHOOTING CHART:

The Problem	The Cause	The Solution
Does not toast...	a. Toaster cold. b. Wrong power switch position. c. Wrong conveyor speed setting.	a. Allow five (5) minutes for warm up. b. Position power switch to full power. c. Reduce conveyor speed.
Toasts unevenly...	d. Only part of product surface is toasted e. Product located too far to side of conveyor.	d. Reduce conveyor speed. e. Place product on conveyor between end links.
Product sticks to conveyor or slide..	f. Butter or butter substitute used on product g. Conveyor surface has baked-on oil residue h. Very moist or doughy product. i. Product not defrosted or thawed.	f. Discontinue use of butter or butter substitute. g. Follow daily cleaning methods to remove & prevent residue. h. Use different source or day-old product. i. Defrost/thaw product.
No power...	j. No power to receptacle. k. Toaster unplugged. l. Loose connections. m. Power switch.	j. Check circuit breaker. k. Plug in toaster. l. Check connections. m. Check that switch is on & operational.
Does not heat...	n. Loose connections. o. Faulty power switch. p. Burnt out element.	n. Check connections. o. Replace power switch. p. Replace element.
Lighter toast under peak loads	q. Speed control setting. r. Very moist product. s. Product too cold. t. Toaster cavity temperature being quenched	q. Reduce speed control setting. r. Use different source or day old product. s. Allow product to warm to room temperature. t. Add 1" or more spacing between product.
Conveyor does not move	u. No power. v. Conveyor links are binding. w. Drive chain too loose or too tight x. Loose or bad connection between speed control and conveyor motor y. Conveyor motor burnt out. z. Speed control burnt out.	u. Check circuit breaker. v. Check conveyor for bent links. w. Adjust drive chain. x. Check for loose or bad connection y. Replace conveyor motor. z. Replace speed control.

EXPLODED VIEW

EXPLODED VIEW- AT EXPRESS

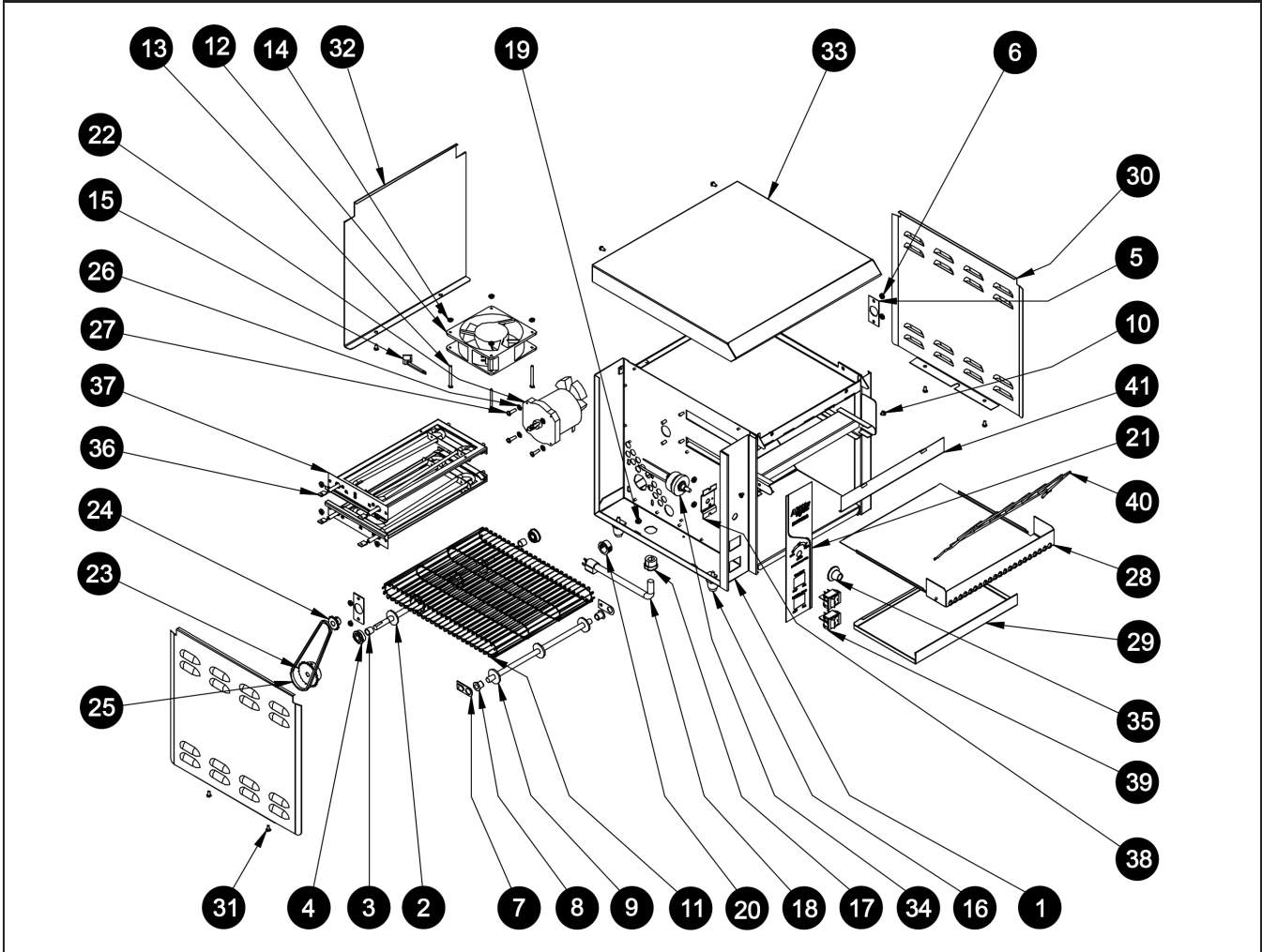

Item	P/N	Description	Qty
1	93300010	W'ASSY, MAIN BODY	1
2	83956	DRIVE SHAFT ASSY AT-10 SEGMENTED BELT	1
3	93300058	SPACER, CONVEYOR SHAFT	2
4	83248	BEARING, SHAFT	2
5	83821	BRACKET, BEARING	2
6	89061	NUT, HEX 10-24	10
7	38132	W'ASSY BEARING CLIP	2
8	38125	BEARING FLANGED POLYMER	2
9	38122	W'ASSY IDLER SHAFT	1
10	88954	SCREW, 8-32X3/16, PH, PH, SS	2
11	PS0018	PS; BELT; WIRE 3 SEGMENT KIT	1
12	85286	FAN MOTOR COOLING 120V 4.5"	1
13	88923	SCREW, 8-32x1-3/4 SLT PAN MS SS	4
14	89063	NUT, HEX 8-32	4
15	85283	CORD, FAN	1

Item	P/N	Description	Qty
16	83267	LEG 1" PLASTIC W/CHROME	4
17	89111	BUSHING, STRAIN RELIEF SR-7W-2	1
18	85638	CORDSET 14/3 600V .440 DIA HSJO 5-20P	1
19	88961	NUT, HEX 10-24, GREEN	1
20	89184	BUSHING, .875 HEYCO 2126	1
21	93300029	LABEL CONTROL PANEL	1
22	85152	MOTOR AT10 115V 60HZ 3RPM MK 5-3902	1
23	83260	SPROCKET, 18 TOOTH 1/4 PITCH 5/16 BORE	1
24	83261	SPROCKET, 12 TOOTH 1/4 PITCH 3/8 BORE	1
25	82903	CHAIN, 1/4" DRIVE 65 PITCH	1
26	89059	WASHER #10 EXTERNAL LOCK	4
27	89006	SCREW, 10-24x5/8 PAN HD SLOT	4
28	93300013	TRAY REFLECTOR	1
29	38129	DRAWER TOAST	1
30	38136	COVER SIDE	2
31	89039	SCREW, 8-32X5/16 PH PAN SS	8
32	93300026	COVER BACK	1
33	93300016	COVER, TOP	1
34	83221	RHEOSTAT, MOTOR CONTROL 120V	1
35	75617	KNOB W/NO'S. 0 TO 9	1
36	93300017	ELEMENT, 120V 832W	2
37	93300018	W/ASS'Y, ELEMENT RACK	2
38	93100063	XPRS-PLATE, CONTROL PANEL	1
39	89491	SWITCH, ROCK, DPST, 20A 250VAC, BLK (TEXT)	2
40	38131	FEEDER, WIRE	1
41	93300031	BAFFLE, HEAT	1

WIRING DIAGRAM

WIRING DIAGRAM- AT EXPRESS

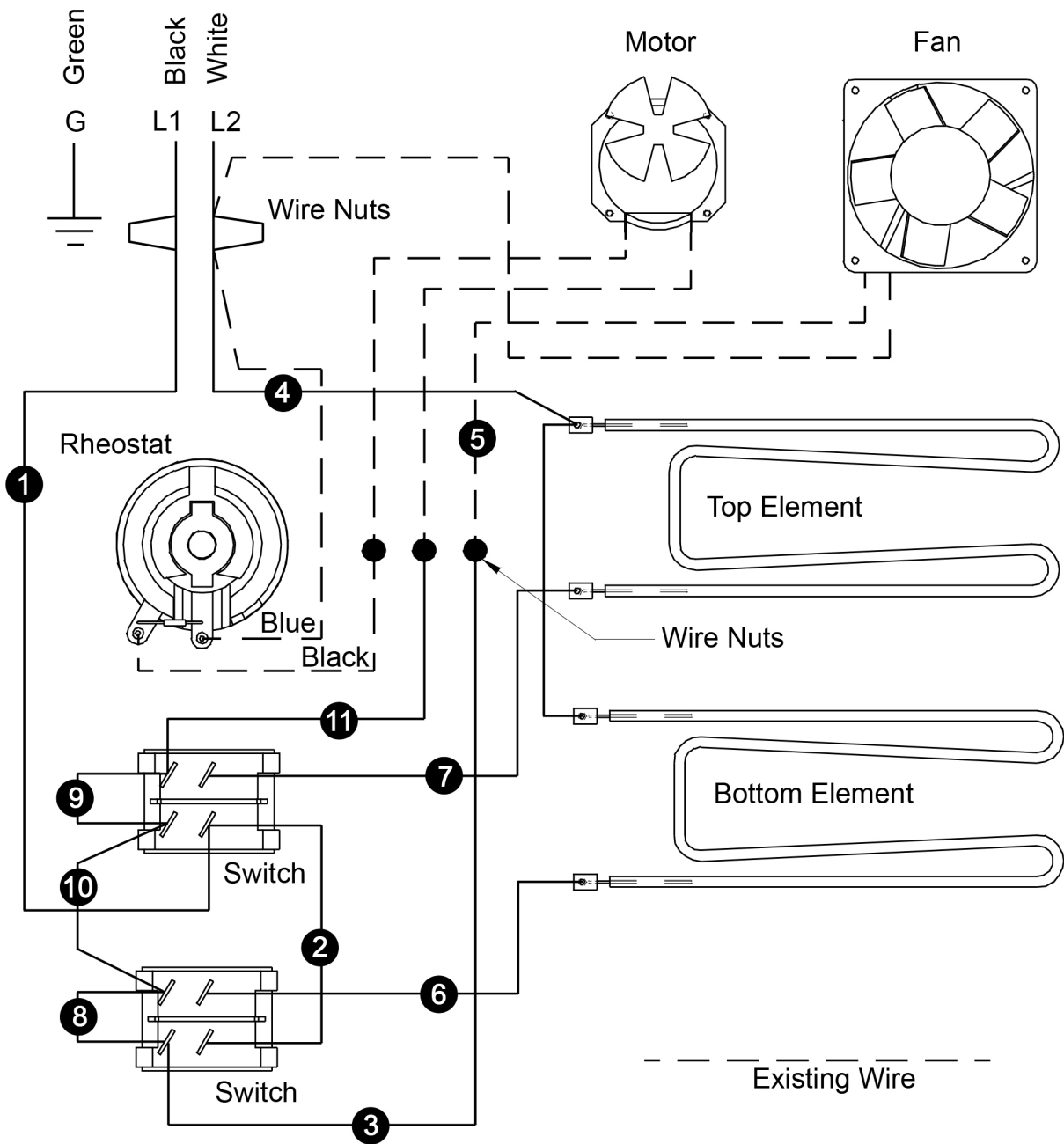

IMPORTANT NOTICE: The information contained in this section of the manual is intended for individuals possessing backgrounds of electrical and mechanical experience, such as an authorized APW Wyott service technician. APW or the seller cannot be responsible for the interpretation of this information, nor can it assume any liability in connection with its use.

LIMITED EQUIPMENT WARRANTY

APW (as well as its subsidiaries) warrants to the original purchaser of new APW's products to be free from defects in material or workmanship, under normal and proper use and maintenance service as specified by APW and upon proper installation and start-up in accordance with the instructions supplied with each APW unit. APW's obligation under this warranty is limited to a period of one [1] year beginning from the date of original installation. The warranty period begins upon the earlier of the date of original installation or up to six [6] months after the original shipment, from the factory, of the covered product. Defects that occur as a result of normal use, within the time period and limitations defined in this warranty, will at APW's discretion have the parts replaced or repaired by APW or a APW's-authorized service agency.

THIS WARRANTY IS SUBJECT TO ALL LISTED CONDITIONS

Repairs performed under this warranty are to be performed by an APW authorized service agency. APW will not be responsible for charges incurred or service performed by non-authorized repair agencies. In all cases, the nearest APW-authorized service agency must be used. APW will be responsible for normal labor charges incurred in the repair or replacement of a warrantied product within 50 miles (80.5 km) of an authorized service agency. Time and expense charges for anything beyond that distance will be the responsibility of the owner. All labor will need to be performed during regular service hours. Any overtime premium will be charged to the owner. For all shipments outside the U.S.A. and Canada, please see the International Warranty for specific details. It is the responsibility of the owner to inspect and report any shipping damage claims, hidden or otherwise, promptly following delivery. No mileage or travel charges will be honored on any equipment that is deemed portable. In general, equipment with a cord and plug weighing less than 50 lb. (22.7 kg) is considered portable and should be taken or shipped to the closest authorized service agency, transportation prepaid.

CONTACT

Should you require any assistance regarding the operation or maintenance of any APW Manufacturing; phone or email our service department. In all correspondence provide the model number and serial number of the unit needing service; include the voltage or gas type.

Normal Business Hours: 8:00 a.m. to 5:00 p.m. Central

Telephone: 800-264-7827 Tech Service Option 2

Email: TechService@partstown.com

www.apwwyott.com

WARRANTY EXCLUSIONS

THE FOLLOWING WILL NOT BE COVERED UNDER WARRANTY.

APW's sole obligation under this warranty is limited to either repair or replacement parts, subject to the additional limitations detailed below. This warranty neither assumes nor authorizes any person to assume obligations other than those expressly covered by this warranty.

- Any product which has not been used, maintained, or installed in accordance with the directions published in the appropriate installation sheet and/or owner's manual, including incorrect gas or electrical connection. APW is not liable for any unit which has been mishandled, abused, misapplied, subjected to harsh chemicals, modified by unauthorized personnel, damaged by flood, fire, or other acts of nature [or God], or which have an altered or missing serial number.
- Installation, labor, and job checkouts, calibration of heat controls, air and gas burner/bypass/pilot adjustments, gas or electrical system checks, voltage and phase conversions, cleaning of equipment, or seasoning of griddle surface.
- Replacement of fuses or resetting of circuit breakers, safety controls, or reset buttons.
- Replacement of broken or damaged glass components, quartz heating elements, and light bulbs.
- Labor charges for all removable and consumable parts in gas charbroilers and hotplates, including but not limited to burners, grates, and radiants.
- Any labor charges incurred by delays, waiting time, or operating restrictions that hinder a service technician's ability to perform service.
- Replacement of parts that fail or are damaged due to normal wear or labor for replacement of parts that can be replaced during a daily cleaning routine, such as but not limited to silicone belts, PTFE non-stick sheets, control labels, knobs, bulbs, fuses, quartz heating elements, baskets, racks, and grease drawers.
- Any economic loss of business or profits.
- Non-OEM parts. Use of non-OEM parts without APW's approval will void the warranty.
- Units exceeding one [1] year from original installation date.

ADDITIONAL WARRANTIES

- Specific/chain-specific equipment may have additional and/or extended warranties.

The foregoing warranty is in lieu of any and all other warranties expressed or implied and constitutes the entire warranty.



APW Wyott • www.apwwyott.com/
265 Hobson St. • Smithville, TN 37166
Telephone: (800) 527-2100

Printed in the U.S.A. • 2M-93300045 • REV D (12-23)
Specifications are subject to change without notice.

APW
wyott is a registered trademark of APW Wyott®, A Middleby Company.
All rights reserved.