

Complete Sectionizer Model

Complete Sectionizer unit comes with Blade Cup of your choice, and corresponding Plunger.

Units Per Master Ctn.	Weight Per Master Ctn.	Suggested List Price
1	15	\$230.00

Complete Model	Blade Cup Style	Description
S-101	4 Wedge	4 evenly spaced and cut wedges.
S-102	6 Wedge	6 evenly spaced and cut wedges.
S-103	6 Slice	6 slices 5/16" thick. Must use plunger #10.
S-104	8 Wedge	8 evenly spaced and cut wedges.
S-105	3-in-1	2 halves scored in 3 wedges each (primarily for school foodservice).
S-107	Single	Cuts fruits & vegetables in half.

Basic Sectionizer Model

S-100 – Basic Sectionizer Unit
No Plunger and No Blade Cup

Units Per Master Ctn.	Weight Per Master Ctn.	Suggested List Price
1	14	\$200.00

Apple Sectionizer Model

S-106 – Apple Model
6 evenly spaced and cut wedges with center core removed.

Units Per Master Ctn.	Weight Per Master Ctn.	Suggested List Price
1	15	\$250.00

Tomato Sectionizer Model

S-109 – Serrated Blades - Tomato Model
7 evenly spaced and sliced - recommended for tomatoes, kiwis, mushrooms, strawberries and hardboiled eggs.

Units Per Master Ctn.	Weight Per Master Ctn.	Suggested List Price
1	15	\$225.00

Individual Parts – Optional

8 wedge, 6 wedge, 4 wedge, 3-in-1 and single wedge cups are interchangeable and use the same plunger. A wedger may be changed to a slicer or slicer to wedger by replacing cup, plunger and neoprene cup cover.
S-32 Apple Blade Cup can only be used with S-33 Apple Plunger.

Part Number	Parts Description	Price
S-1	Foot Pad (set of 6)	\$ 4.00
S-2	Base Assembly	120.00
S-3B	Blade Cup w/cover (6 wedge) (fits S-9)	48.00
S-4B	Blade Cup w/cover (6 slice) (fits S-10)	62.00
S-5B	Blade Cup w/cover (4 wedge) (fits S-9)	46.00
S-6	Wedger Cup cover (sold w/S-3, S-5, S-29, S-30, S-32, S-35)	12.00
S-7	Slicer Cup cover (sold w/S-4)	12.00
S-8	Outer Shell	60.00
S-8D	Pin & Thread Assembly	6.00
S-9	Plunger Wedger (fits parts S-3, S-5, S-29, S-30, S-35)	24.00
S-10	Plunger Slicer (fits S-4)	24.00
S-11	Crossbar Assembly	48.00
S-11C & D	Crossbar Assembly Screw Set	2.00
S-12	Back Screw #8 x 1/2" (set of 8)	2.00
S-13	Back Cover	26.00
S-14	Spring Pin (set of 2)	2.00
S-15	7 Slice Blade Cup w/cover (fits S-16)	76.00
S-16	Plunger Tomato Slicer (fits part S-15)	28.00
S-17	Tomato Set (S-15 & S-16)	98.00
S-23	Gears & Shaft Set	58.00
S-24	Base Side Screw 6-32 x 1 1/2" (set of 10)	2.00
S-25	Plastic Shaft Cover	8.00
S-26	Handle	16.00
S-27	Knob	14.00
S-28	Bottom Screw #8 x 1 1/2" (set of 4)	2.00
S-29B	Blade Cup w/cover (8 wedge) (fits S-9)	50.00
S-30B	Blade Cup w/cover (3-in-1) (fits S-9)	56.00
S-31	Plastic Production Stand (see below)	100.00
S-32B	Apple Corer Cup (fits S-33)	84.00
S-33	Apple Plunger (fits S-32)	30.00
S-34	Apple Corer Set (S-32 & S-33)	100.00
S-35B	Blade Cup w/cover (single) (fits S-9)	44.00

Plastic Production Stand (Optional)









Part Number S-31



A sturdy plastic stand that allows serving pans to pass under the sectionizer for greater production flexibility.

Overall dimensions 5 3/4" high, 14 1/2" wide
Shipping Weight 2 lbs., 3 oz.

Blade Cup Styles

	PLUNGER S-9 CUP S-5
4 Wedge	
	PLUNGER S-9 CUP S-3
6 Wedge	
	PLUNGER S-10 CUP S-4
6 Slice	
	PLUNGER S-9 CUP S-29
8 Wedge	
	PLUNGER S-9 CUP S-30
3-in-1	
	PLUNGER S-33 CUP S-32
Apple Model	
	PLUNGER S-9 CUP S-35
Single	
	PLUNGER S-16 CUP S-15
Tomato Model	

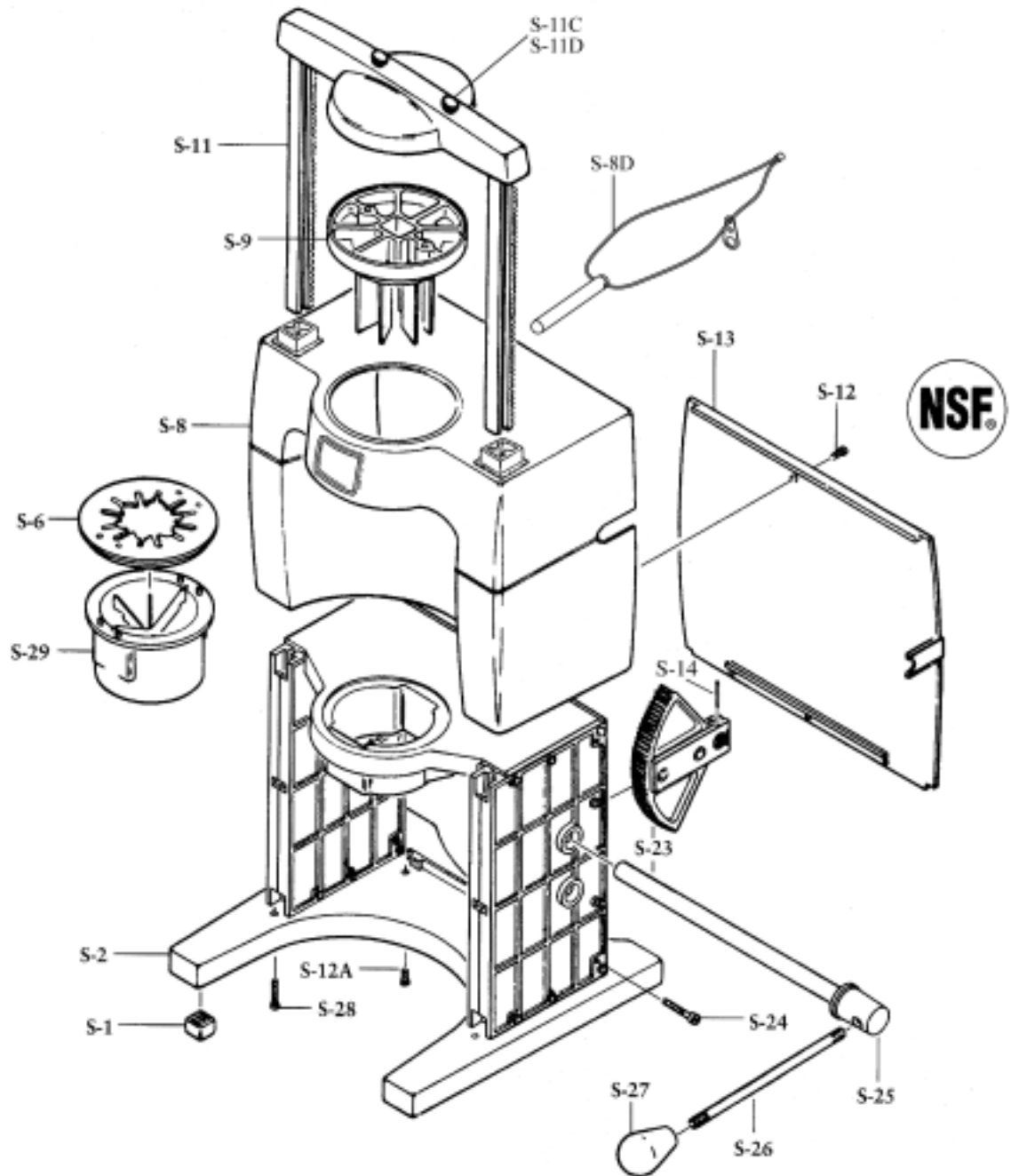

Complete Sectionizer Specifications

Safe...Listed by NSF International®.

Overall dimensions15½" high, 15¼" wide, 13⅞" deep
 Net weight13 pounds
 Shipping weight15 pounds
 Cube2.32
 Carton size17½" high, 17¼" wide, 13¼" deep

www.sunkistfs.com/equipment

All prices quoted are subject to change without notice. The amount of any present or future tax shall be paid by the purchaser. Address all inquiries to your local dealer, or contact Sunkist Foodservice Equipment Customer Service at (800) 383-7141.

Products must not be returned to Sunkist without a return authorization number.