

Statement of Responsibilities

This document is for use by experienced and trained Qualified Cleveland Range, LLC Authorized Service Representatives who are familiar with both the safety procedures, and equipment they service.

Cleveland Range, LLC assumes no liability for any death, injury, equipment damage, or property damage resulting from use of, improper use of, or failure to use the information contained in this document.

Cleveland Range, LLC has made every effort to provide accurate information in this document, but cannot guarantee that this document does not contain unintentional errors and omissions.

The information in this document may be subject to technical and technological changes, revisions, or updates.

Cleveland Range, LLC assumes no liability or responsibility regarding errata, changes, revisions, or updates.

Qualified Cleveland Range, LLC Authorized Service Representatives are obligated to follow industry standard safety procedures, including, but not limited to, OSHA regulations, and disconnect / lock out / tag out procedures for all utilities including steam, and disconnect / lock out / tag out procedures for gas, electric, and steam powered equipment and / or appliances

All utilities (gas, electric, water and steam) should be turned OFF to the equipment and locked out of operation according to OSHA approved practices during any servicing of Cleveland Range equipment

Qualified Cleveland Range, LLC Authorized Service Representatives are obligated to maintain up-to-date knowledge, skills, materials and equipment.

SteamCraft® Power 10

TWO COMPARTMENT FLOOR MODEL DESIGN
GAS-FIRED STEAM GENERATOR, 240 M BTU
24" WIDE MODULAR DESIGN

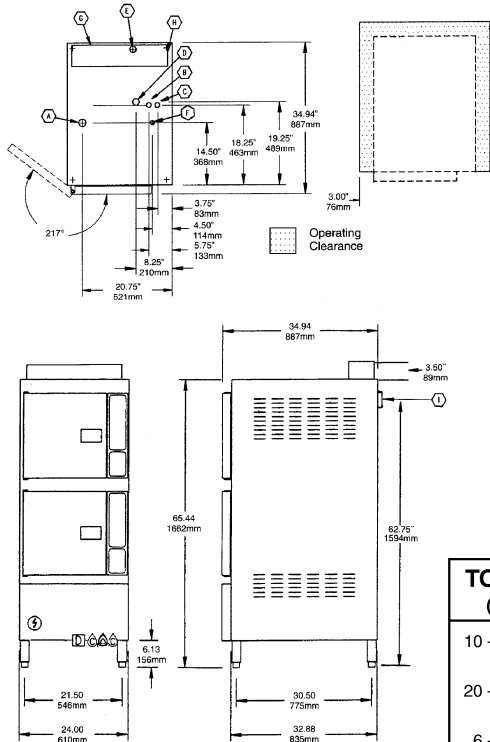

TOTAL CAPACITY (2 Compartments)

- 10 — 12" x 20" x 2 1/2" Cafeteria Pans or
- 20 — 12" x 20" x 1" Cafeteria Pans or
- 6 — 12" x 20" x 4" Cafeteria Pans

UTILITY CONNECTIONS

- (A) Electrical Supply
- (B) Cold Water Supply for Condenser 3/8" Dia. IPS
- (C) Cold Water Supply for Generator and Water Injection. 3/8" Dia. IPS (for water treatment conn.) Unit comes with a 50 Mesh Water Strainer (installation required)
- (D) Drain: 1.50" (38mm) Dia.
- (E) Inlet for Generator Deliming Solution
- (F) Gas Supply .75" (13mm) Dia.
- (G) Flue Gas Exhaust from Boiler
- (H) Flue Diverter
- (I) Power Take Off Connection

MODEL: 24-CGP-10

ITEM NUMBER _____

JOB NAME / NUMBER _____

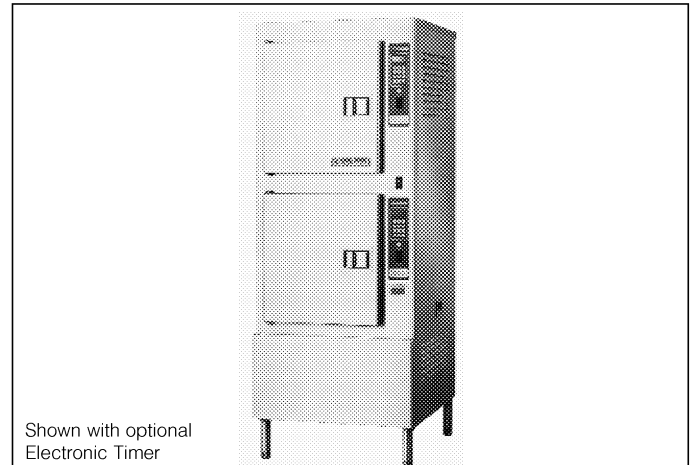

SHORT FORM SPECIFICATION







Shall be CLEVELAND, SteamCraft® Power 10, two compartments, Floor Model Steamer, Model 24-CGP-10. Single, large capacity Gas-fired Pressure Steam Generator, 240M BTU input. Patented Automatic Water Level Float design. Steam Generator with Automatic Water Fill on start up, Automatic Generator Blowdown, Electronic Spark Ignition and Generator Standby for instant steam. Choice of Compartment Controls, Manual By Pass Operation Mode. Patented Cold Water Condenser design.

WATER QUALITY REQUIREMENT

The quality of water varies greatly from region to region. *Steam equipment must be blown down daily and chemically descaled periodically to ensure proper operation.* To minimize service problems caused by the accumulation of minerals and chemicals in water, review the following quality guidelines with a local water treatment specialist. Inlet water that is beyond these specified guidelines should be treated to achieve the acceptable limits.

TOTAL DISSOLVED SOLIDS	less than 60 parts per million
TOTAL ALKALINITY	less than 20 parts per million
SILICA	less than 13 parts per million
pH FACTOR	greater than 7.5
CHLORINE	less than 30 parts per million

A typical water quality analysis can be secured from your local water district. Water that is potable does not guarantee compatibility with steam equipment.

GAS 	ELECTRIC 	COLD WATER 	DRAINAGE 	CLEARANCE				
240,000 BTU - Piping 1 1/2" IPS Line Size, 3/4" Connection	115V - 1 Phase 1 Fan & Controls - 150 Watts	35 psi minimum 60 psi maximum  3/8" Dia. IPS for Generator (for SteamerGuard connection)  3/4" Dia. IPS for Condenser	1 1/2" Dia. Do not connect other units to this drain. Drain line must be vented. No PVC pipe for drain.	Right - 6.00" Left - 3.00" Rear - 3.00"				
SUPPLY PRESSURE <table border="1"> <thead> <tr> <th>NATURAL</th> <th>PROPANE</th> </tr> </thead> <tbody> <tr> <td>4.00" W.C. minimum 14.00" W.C. maximum</td> <td>12.00" W.C. minimum 14.00" W.C. maximum</td> </tr> </tbody> </table>		NATURAL	PROPANE	4.00" W.C. minimum 14.00" W.C. maximum	12.00" W.C. minimum 14.00" W.C. maximum			
NATURAL	PROPANE							
4.00" W.C. minimum 14.00" W.C. maximum	12.00" W.C. minimum 14.00" W.C. maximum							
Manufacturer must be notified if unit will be used above 2,000 ft. altitude.								

Cleveland Range reserves right of design improvement or modification, as warranted.

CLEVELAND RANGE
SEQUENCE OF OPERATIONS
24CGP10
Mechanical Timer

1. To turn the unit on, depress the red on/off rocker switch.
 - 115 VAC is sent to normally open blowdown valve closing it.
 - 115 VAC is sent to the Timed/Manual switches for the cabinets.
 - 115 VAC is sent to L1 and L2 of the water level board.

2. With the water level board energized and no water in the boiler
 - 115 VAC is sent from the IND terminal to the low water indicator light on the console.
 - 115 VAC is sent from the WF terminal to the fill solenoid after a 5-second delay.
 - The fill solenoid opens and the boiler fills.
 - The water fills to the secondary low water cutoff probe in the boiler, shorting it to ground
 - 115 VAC is removed from the IND terminal and the low water indicator light is de-energized.
 - 115 VAC is sent from the HTR terminal through the normally closed contact of the high-pressure switch to the amber reset switch,
 - 115 VAC is sent through the normally closed R1 contacts to energize the amber light.
 - If the low water cut off probe is not grounded for 20 seconds, 115 VAC is removed from HTR and sent back to IND energizing the low water light.

3. When the momentary amber switch is depressed 115 VAC is sent to the R1 relay closing it.
 - The normally closed R1 contacts open de-energizing the amber light.
 - The relay latches through the normally closed contacts of R1
 - If either the high-pressure switch (set at 15 PSI) or the low probe circuit on the water level board opens, then the latch circuit opens.
 - When the water level or pressure returns to a safe condition the amber light will energize and the process may begin again.

4. The R1 relay contacts close sending 115 VAC through the normally closed operating pressure switch to the 24 VAC transformer.
 - 24VAC is sent through the low water cutoff float switch to the R2 relay coil.
 - The normally open R2 contacts close and send 115 VAC to the fan.
 - The fan turns and the air prover switch is closed.
 - 24 VAC is sent through the air prover switch to the ignition module.
 - With 24 VAC to the ignition module 24VAC is sent to the pilot coil on the gas valve.
 - A spark is generated at the igniter.
 - The pilot valve is energized and opens.
 - Gas is sent to the pilot burner.
 - The gas is ignited and the flame rectifies the AC current.

- When the ignition module reads 1.0 micro amps DC current through the ground wire the coil to the main gas valve is energized
 - The pilot flame lights the main burner.
 - If the module does not read 1.0 micro amps DC in 90 seconds it will shut down the main burner and make one more try before locking out.
5. The water in the boiler is heated to steam.
 - As steam is generated and pressure builds the air is pushed out through the steamtrap on the lower steam manifold.
 - Steam goes through the steam trap heating it to 192 degrees closing the steam trap.
 6. Pressure builds in the boiler to the set point of 8-10 PSI.
 - The operating pressure switch opens and the heat circuit is de-energized.
 7. With the timed/manual switch in the timed position and time on the timer.
 - 115 VAC is sent to the steam solenoid and steam is sent to the cooking cabinet. There the steam is directed around the product.
 - 115 VAC is sent to the “Pause” or “Sure Cook” light.
 - 115 VAC is sent to the normally open contacts of the compartment thermostat.
 - The normally open contacts of the compartment thermostat close when the compartment temperature reaches 193 degrees
 - 115 VAC is sent to the timer motor and the timer begins to count down.
 - 115 VAC is sent to the condensate solenoid and cold water is sent to the condensate spray nozzle pulling the steam down the drain.
 - When the steam pressure drops below the operating set point the heat circuit is energized and the heat process begins again.
 8. Water continues to fill the boiler until the operational water float is lifted and closes, shorting the HI terminal on the water level board to the C terminal. .
 - When the HI terminal is shorted to the C terminal the WF terminal on the water level board is de-energized.
 - If the water level drops below the operational water float switch for more than 5 seconds the WF terminal is energized and the water fill circuit begins again.
 9. When the mechanical timer counts down:
 - 115 VAC is removed from the condensate circuit.
 - 115 VAC is removed from the steam solenoid.
 - 115 VAC is sent to the 3-second timer
 - 115 VAC is sent from the 3-second timer to the buzzer for 3 seconds.
 10. With the timed/manual switch in the Manual position
 - 115 VAC is sent to the steam solenoid and steam is sent to the cooking cabinet. There the steam is directed around the product.
 - 115 VAC is sent to the “Pause” or “Sure Cook” light.
 - 115 VAC is sent to the normally open contacts of the compartment thermostat.
 - The normally open contacts of the compartment thermostat close when the compartment temperature reaches 193 degrees

- 115 VAC is sent to the condensate solenoid and cold water is sent to the condensate spray nozzle pulling the steam down the drain.
- When the steam pressure drops below the operating set point the heat circuit is energized and the heat process begins again.

11. The unit is turned off by depressing the red rocker switch.

- 115 VAC is removed from the timing and heat circuits.
- 115 VAC is removed from the normally open blowdown valve allowing the unit to drain.
- 115 VAC is sent to the 3-minute timer.
 - The three-minute timer will energize the fill and rinse solenoids for 3 minutes while the steamer drains assisting and cooling the blowdown. .

STEAMCRAFT 10 PRESSURE, GAS - MECHANICAL TIMER

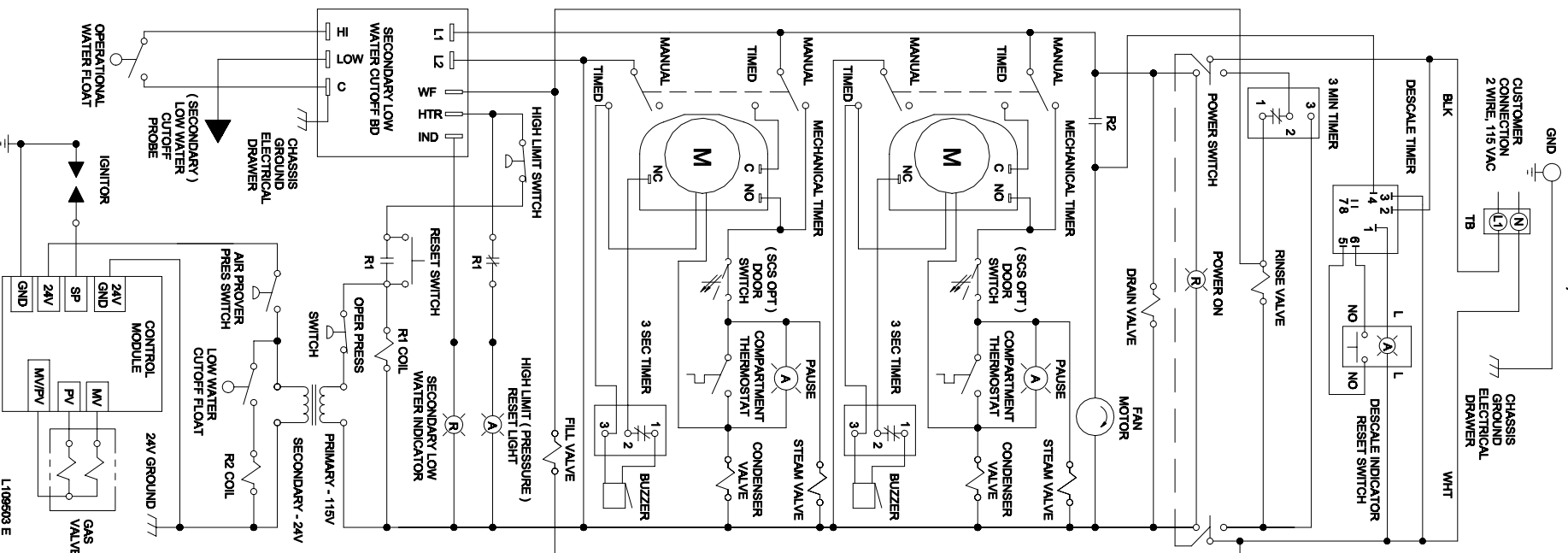

STEAMCRAFT 10 PRESSURE, GAS-MECHANICAL TIMER

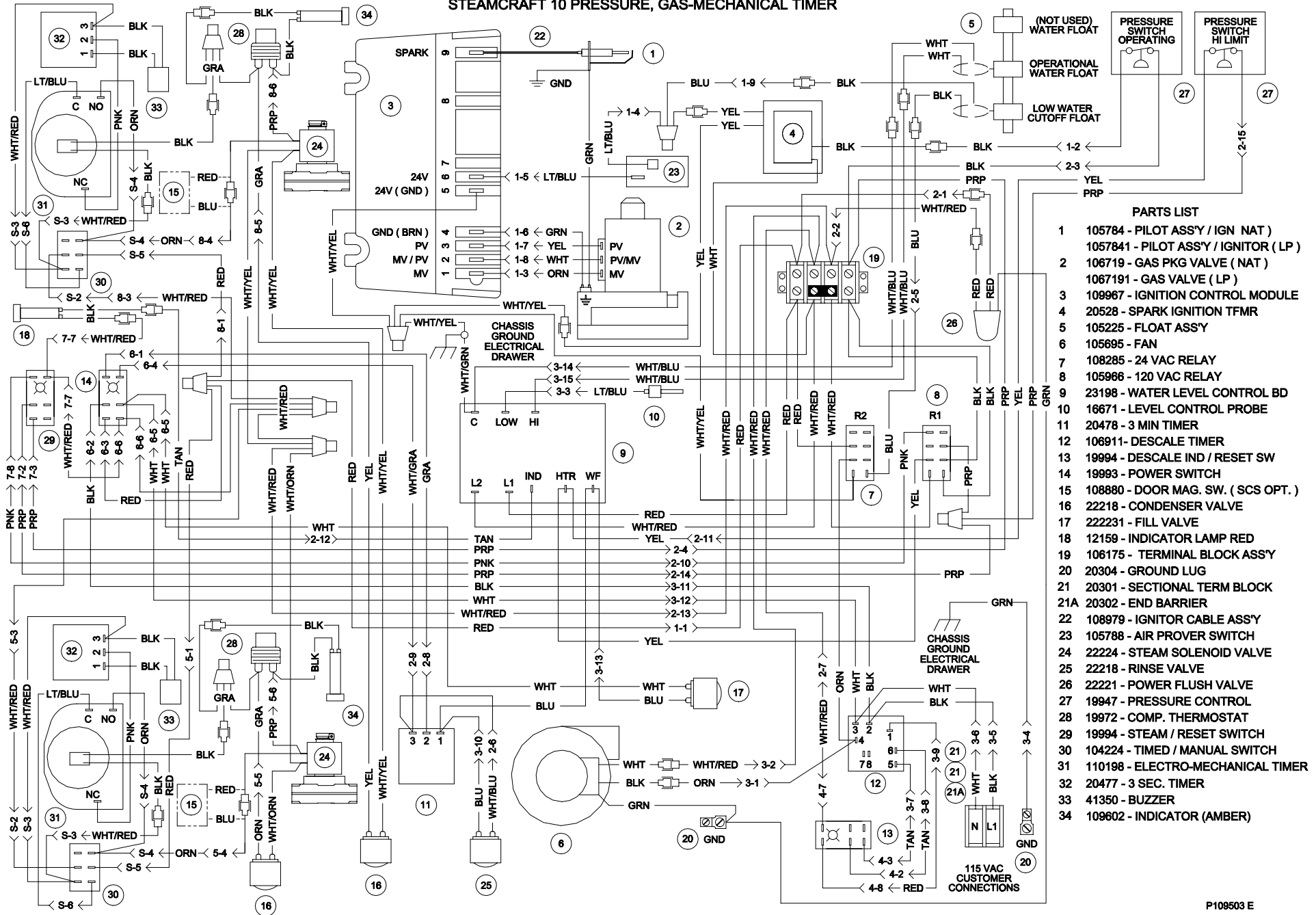

PARTS LIST

- 1 105784 - PILOT ASSY / IGN NAT)
1057841 - PILOT ASSY / IGNITOR (LP)
- 2 106719 - GAS PKG VALVE (NAT)
1067191 - GAS VALVE (LP)
- 3 109967 - IGNITION CONTROL MODULE
- 4 20528 - SPARK IGNITION TFMR
- 5 105225 - FLOAT ASS'Y
- 6 105695 - FAN
- 7 108285 - 24 VAC RELAY
- 8 105966 - 120 VAC RELAY
- 9 23198 - WATER LEVEL CONTROL BD
16671 - LEVEL CONTROL PROBE
- 10 20478 - 3 MIN TIMER
- 12 106911- DESCALE TIMER
- 13 19994 - DESCALE IND / RESET SW
- 14 19993 - POWER SWITCH
- 15 108880 - DOOR MAG. SW. (SCS OPT.)
- 16 22218 - CONDENSER VALVE
- 17 222231 - FILL VALVE
- 18 12159 - INDICATOR LAMP RED
- 19 106175 - TERMINAL BLOCK ASS'Y
- 20 20304 - GROUND LUG
- 21 20301 - SECTIONAL TERM BLOCK
- 21A 20302 - END BARRIER
- 22 108979 - IGNITOR CABLE ASS'Y
- 23 105788 - AIR PROVER SWITCH
- 24 22224 - STEAM SOLENOID VALVE
- 25 22218 - RINSE VALVE
- 26 22221 - POWER FLUSH VALVE
- 27 19947 - PRESSURE CONTROL
- 28 19972 - COMP. THERMOSTAT
- 29 19994 - STEAM / RESET SWITCH
- 30 104224 - TIMED / MANUAL SWITCH
- 31 110198 - ELECTRO-MECHANICAL TIMER
- 32 20477 - 3 SEC. TIMER
- 33 41350 - BUZZER
- 34 109602 - INDICATOR (AMBER)

CLEVELAND RANGE
SEQUENCE OF OPERATIONS
24 CGP 10
Electronic Timer

1. To turn the unit on, depress the red on/off rocker switch.
 - 115 VAC is sent to normally open blowdown valve closing it.
 - 115 VAC is sent to the 24 VAC transformer to the timer.
 - 24 VAC is sent to the timer.
 - 115 VAC is sent to the Timed/Manual switches for the cabinets.
 - 115 VAC is sent to L1 and L2 of the water level board.

2. With the water level board energized and no water in the boiler
 - 115 VAC is sent from the IND terminal to the low water indicator light on the console.
 - 115 VAC is sent from the WF terminal to the fill solenoid after a 5-second delay.
 - The fill solenoid opens and the boiler fills.
 - The water fills to the secondary low water cutoff probe in the boiler, shorting it to ground
 - 115 VAC is removed from the IND terminal and the low water indicator light is de-energized.
 - 115 VAC is sent from the HTR terminal through the normally closed contact of the high-pressure switch to the amber reset switch,
 - 115 VAC is sent through the normally closed R1 contacts to energize the amber light.
 - If the low water cut off probe is not grounded for 20 seconds, 115 VAC is removed from HTR and sent back to IND energizing the low water light.

3. When the momentary amber switch is depressed 115 VAC is sent to the R1 relay closing it.
 - The normally closed R1 contacts open de-energizing the amber light.
 - The relay latches through the normally closed contacts of R1
 - If either the high-pressure switch (set at 15 PSI) or the low probe circuit on the water level board opens, then the latch circuit opens.
 - When the water level or pressure returns to a safe condition the amber light will energize and the process may begin again.

4. The R1 relay contacts close sending 115 VAC through the normally closed operating pressure switch to the 24 VAC transformer.
 - 24VAC is sent through the low water cutoff float switch to the R2 relay coil.
 - The normally open R2 contacts close and send 115 VAC to the fan.
 - The fan turns and the air prover switch is closed.
 - 24 VAC is sent through the air prover switch to the ignition module.
 - With 24 VAC to the ignition module 24VAC is sent to the pilot coil on the gas valve.
 - A spark is generated at the igniter.
 - The pilot valve is energized and opens.

- Gas is sent to the pilot burner.
 - The gas is ignited and the flame rectifies the AC current.
 - When the ignition module reads 1.0 micro amps DC current through the ground wire the coil to the main gas valve is energized
 - The pilot flame lights the main burner.
 - If the module does not read 1.0 micro amps DC in 90 seconds it will shut down the main burner and make one more try before locking out.
5. The water in the boiler is heated to steam.
- As steam is generated and pressure builds the air is pushed out through the steamtrap on the lower steam manifold.
 - Steam goes through the steam trap heating it to 192 degrees closing the steam trap.
6. Pressure builds in the boiler to the set point of 8-10 PSI.
- The operating pressure switch opens and the heat circuit is de-energized.
7. With the timed/manual switch in the timed position (with time on the timer) or in the manual position:
- The timer display alternates between “PAUS” and the time set.
 - 115 VAC is sent to the steam solenoid and steam is sent to the cooking cabinet. There the steam is directed around the product and pulled down the drain by the condensate spray.
 - When the cooking compartment reaches 193 degrees internally the thermal switch closes and the timer begins to count down.
 - 115 VAC is sent to the condensate solenoid. The condensate solenoid sends cold water to the condensate spray nozzle pulling the steam down the drain.
 - When the pressure drops below the set point the heat circuit is energized and the heat process begins again.
8. Water continues to fill until the operational water float is lifted and closes, shorting the HI terminal on the water level board to the C terminal. .
- When the HI terminal is shorted to the C terminal the WF terminal on the water level board is de-energized.
 - If the water level drops below the operational water float switch for more than 5 seconds the WF terminal is energized and the water fill circuit begins again.
9. When the electronic timer counts down:
- 115 VAC is removed from the condensate circuit.
 - 115 VAC is removed from the steam solenoid
10. With the timed/manual switch in the manual position
- 115 VAC is sent to the steam solenoid and steam is sent to the cooking cabinet and around the product.
 - 115 VAC is sent to the normally open contacts of the compartment thermostat.

- The normally open contacts of the compartment thermostat close when the compartment reaches 193 degrees.
- 115 VAC is sent to the condensate solenoid and cold water is sent to the condensate spray nozzle pulling the steam down the drain.

11. The unit is turned off by depressing the red rocker switch.

- 115 VAC is removed from the timing and heat circuits.
- 115 VAC is removed from the normally open blowdown valve allowing the unit to drain.
- 115 VAC is sent to the 3-minute timer.
 - The three-minute timer will energize the fill and rinse solenoids for 3 minutes while the steamer drains assisting and cooling the blowdown. .

STEAMCRAFT 10 PRESSURE, GAS - ELECTRONIC TIMER

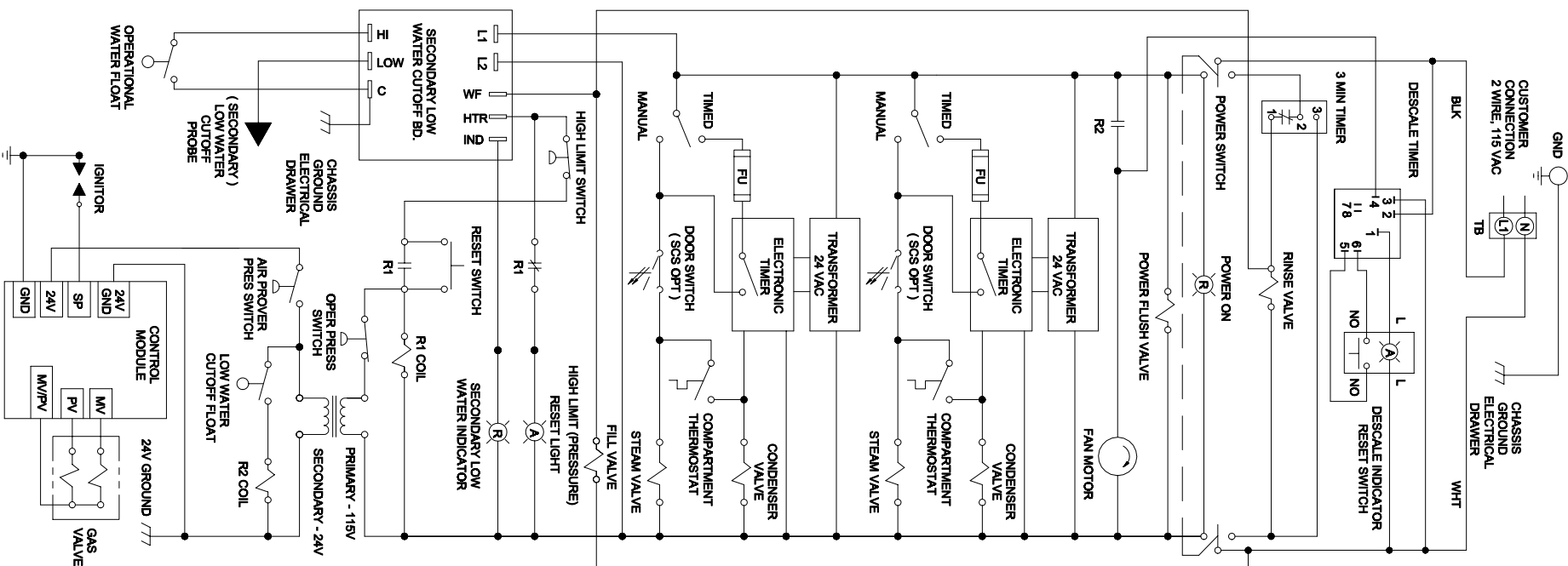

STEAMCRAFT 10 PRESSURE, GAS-ELECTRONIC TIMER

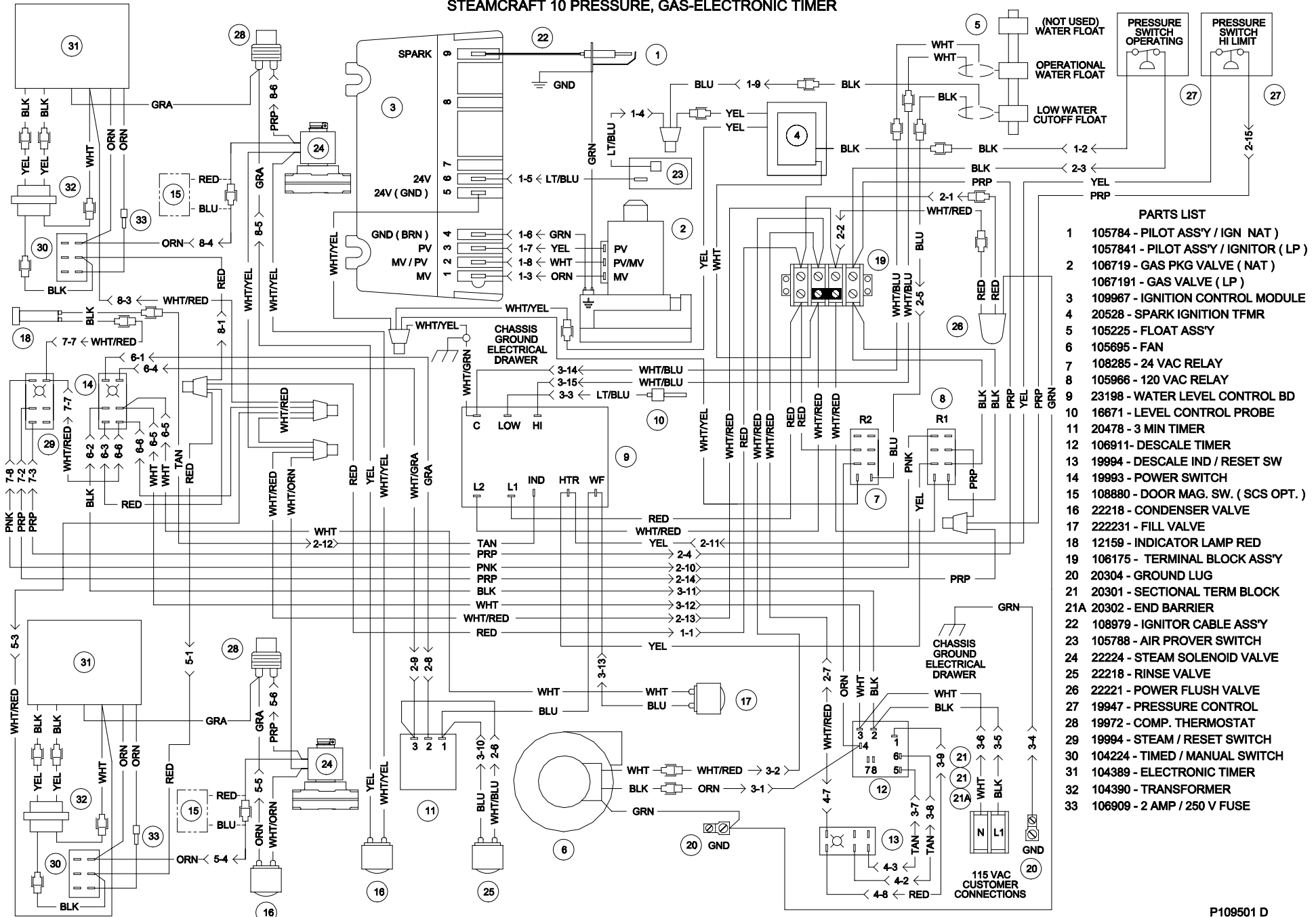

PARTS LIST

- 1 105784 - PILOT ASSY / IGN NAT
- 1057841 - PILOT ASSY / IGNITOR (LP)
- 2 106719 - GAS PKG VALVE (NAT)
- 1067191 - GAS VALVE (LP)
- 3 109967 - IGNITION CONTROL MODULE
- 4 20528 - SPARK IGNITION TFMR
- 5 105225 - FLOAT ASSY
- 6 105695 - FAN
- 7 108285 - 24 VAC RELAY
- 8 105966 - 120 VAC RELAY
- 9 23198 - WATER LEVEL CONTROL BD
- 10 16671 - LEVEL CONTROL PROBE
- 11 20478 - 3 MIN TIMER
- 12 106911-DESCALE TIMER
- 13 19994 - DESCALING IND / RESET SW
- 14 19993 - POWER SWITCH
- 15 108880 - DOOR MAG. SW. (SCS OPT.)
- 16 22218 - CONDENSER VALVE
- 17 222231 - FILL VALVE
- 18 12159 - INDICATOR LAMP RED
- 19 106175 - TERMINAL BLOCK ASSY
- 20 20304 - GROUND LUG
- 21 20301 - SECTIONAL TERM BLOCK
- 21A 20302 - END BARRIER
- 22 108979 - IGNITOR CABLE ASSY
- 23 105788 - AIR PROVER SWITCH
- 24 22224 - STEAM SOLENOID VALVE
- 25 22218 - RINSE VALVE
- 26 22221 - POWER FLUSH VALVE
- 27 19947 - PRESSURE CONTROL
- 28 19972 - COMP. THERMOSTAT
- 29 19994 - STEAM / RESET SWITCH
- 30 104224 - TIMED / MANUAL SWITCH
- 31 104389 - ELECTRONIC TIMER
- 32 104390 - TRANSFORMER
- 33 106909 - 2 AMP / 250 V FUSE

**PROBLEM:
24CGP10 Boiler
won't build
pressure**

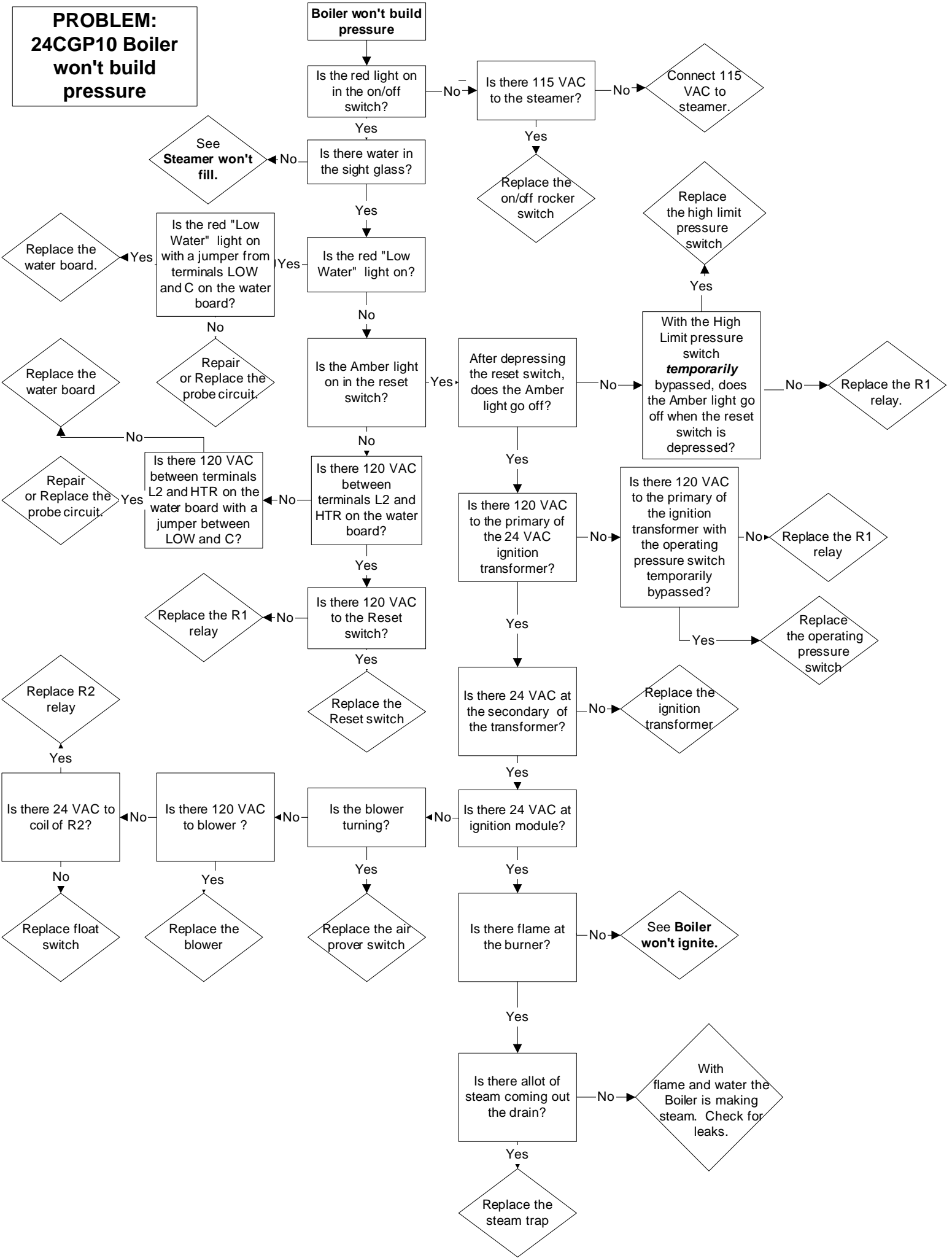

**PROBLEM:
24CGP10
Gas boiler
won't fill**

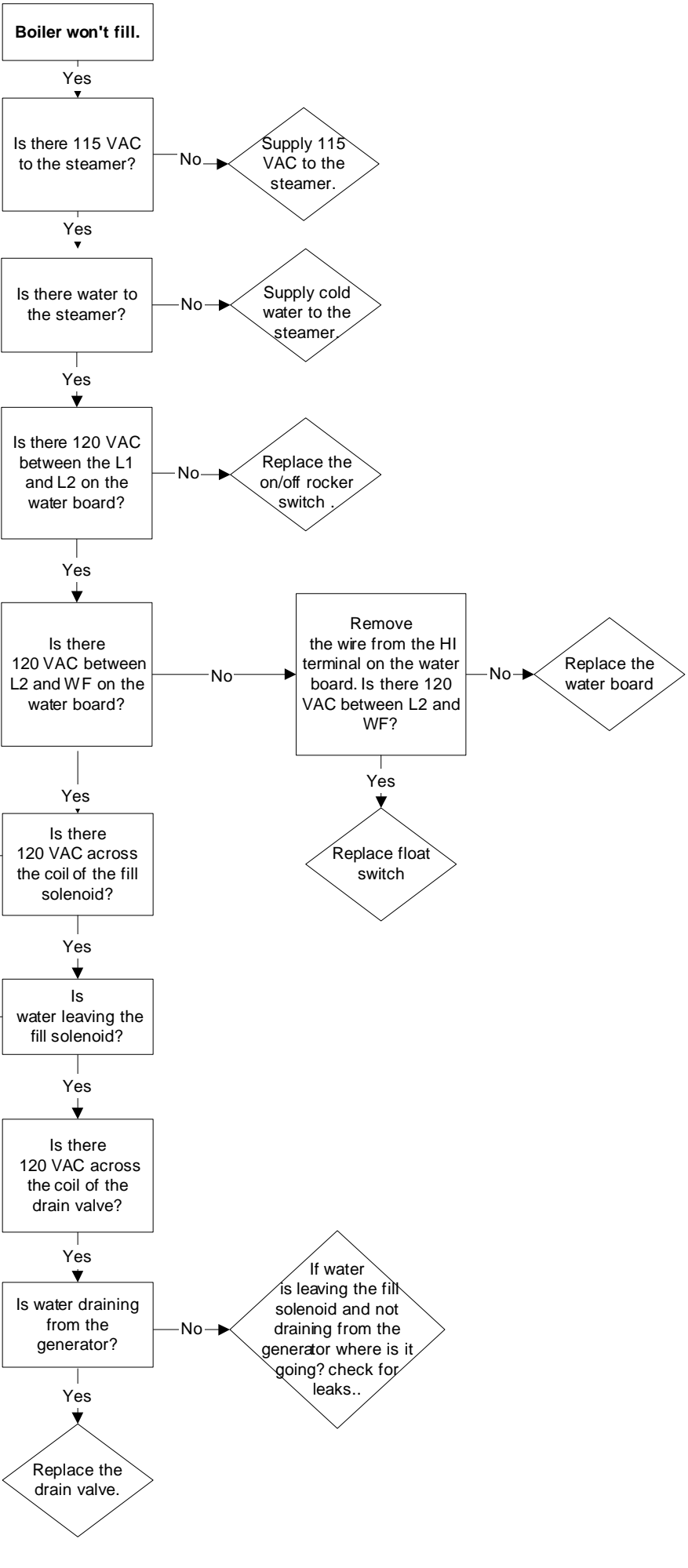

PROBLEM:
24CGP10
Gas boiler
won't ignite

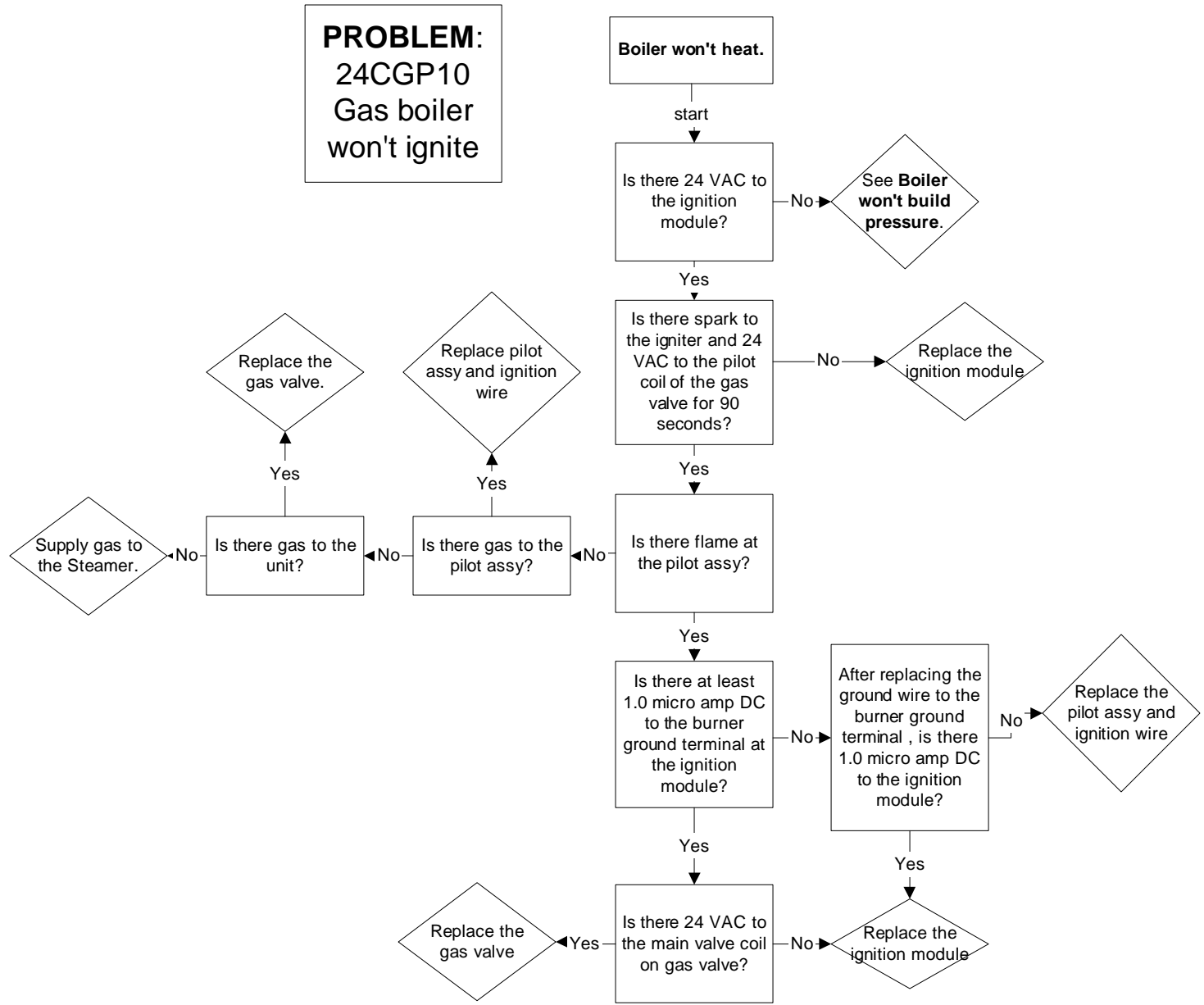

PROBLEM: 24CGP10 Gas Boiler Overfills

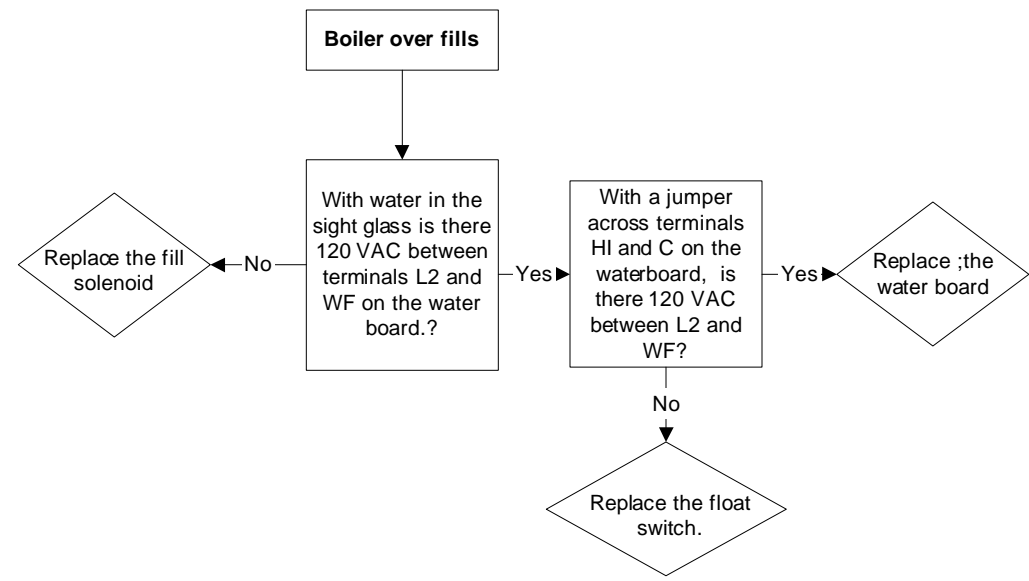

PROBLEM:
 24CGP10
 Gas Boiler Over
 Pressurizes
 (15# Safety
 valve opens)

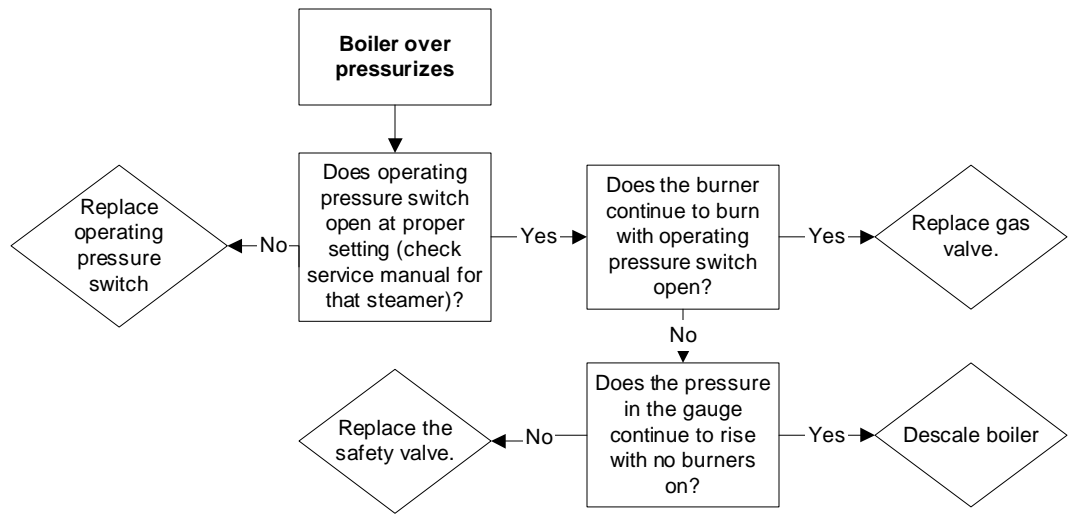

PROBLEM: 24CGP10 Stops Producing Steam

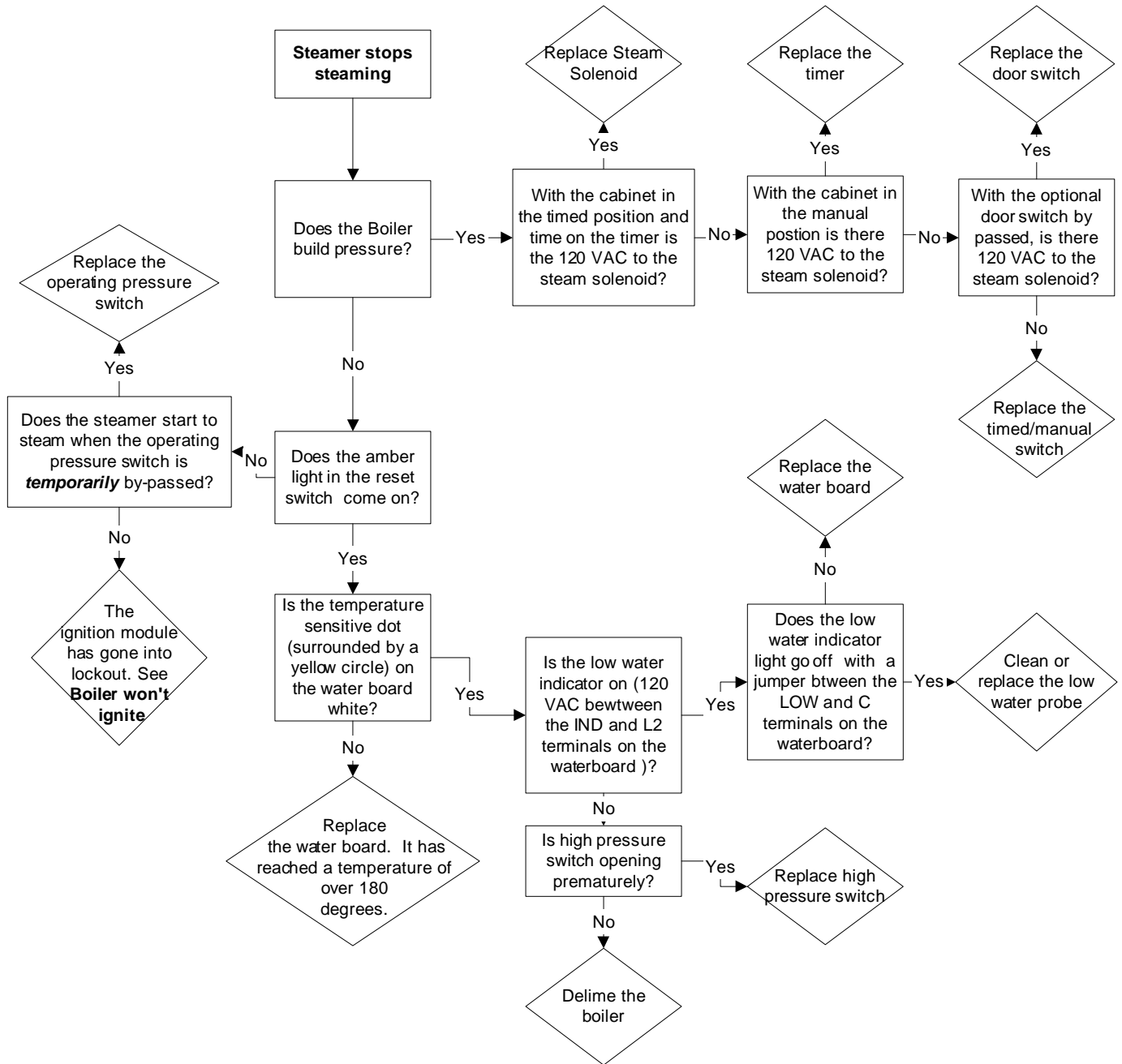

**PROBLEM:
24CGP10
Timer displays "PAUS" ("Sure Cook" light is on) and won't count down**

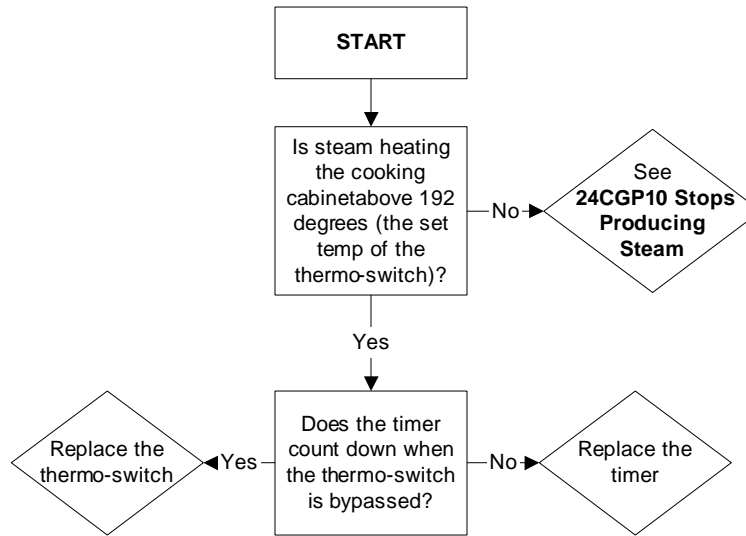

**PROBLEM:
24CGP10
Steam leaks around the door.**

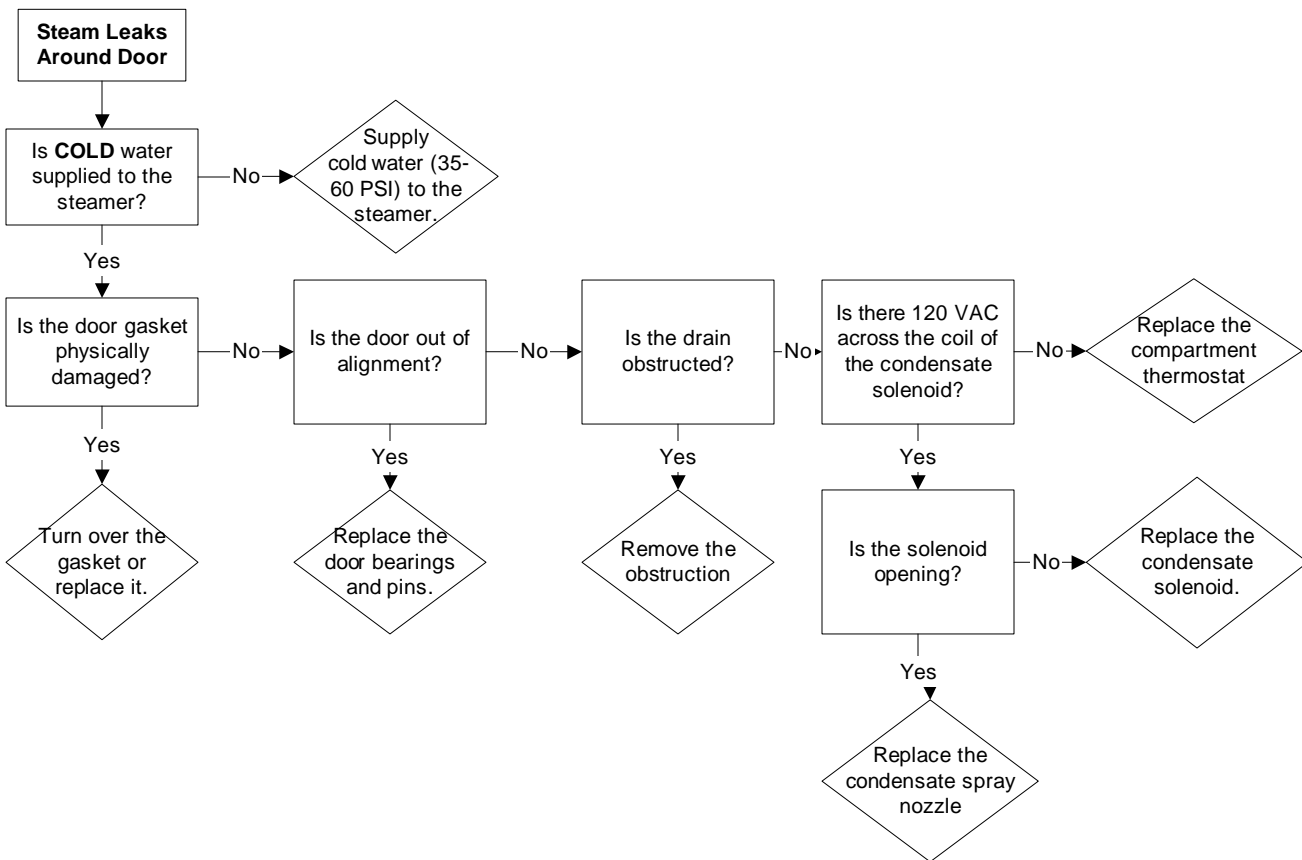

DESCALING INSTRUCTIONS

Steamcraft Power 10
uses Kit P/N: 107142

PRELIMINARY PROCEDURE

- 1) Start with the unit turned off & completely cool.
The boiler will drain for approximately 3 minutes.
- 2) Remove the lower front panel. There are 2 screws holding this panel in place.

GAS BOILER, ORIGINAL P10 (DETAIL "A")

- 1) Check that both ball valves are closed prior to removing the plug on both the inlet (left side) & outlet (right side) ports.
- 2) Attach the 3-inch nipples with attached unions to the inlet & outlet ports.
- 3) Install the 1/2 inch hose with the attached union to the inlet port.
- 4) Install the the 3/4 hose with the attached union to the outlet port.
- 5) Open the sliding view port on the right side panel of the unit. This will expose the float.
- 6) Fill the 5 gallon bucket with 2 gallons of descaler & 3 gallons of water.
- 7) Open the inlet & outlet ball valves attached to the unit. Turn the unit on.
- 8) Turn on the descaler pump & open the inlet valve to the boiler. Let the boiler fill with descaler just above the top of the float. This can be determined by watching the level rise in the float.

1333 East 179th Street
Cleveland, Ohio 44110

Phone: (216) 481- 4900
Fax: (216) 481- 3782



Part No. 260ALQ - E 4/03

9) As the descaler level in the bucket drops, add water so the pump remains submerged.

Note: Liquid level in the descaler bucket should not go below the pump.

10) When the descaler reaches the required level, open the exit valve. make sure the exit line is the bucket. The required level can be maintained by controlling the flow with the ball valves.

11) Let the pump operate for 1 hour.

12) After 1 hour, turn the pump off & close the inlet ball valve. Turn the main switch to off and let drain.

13) Flush the boiler with water when all of the descaler has drained.

14) Turn the unit on to fill with water.

-Fill the 5-gallon bucket with water.

-When the water level reaches the middle of the sight glass, turn on the pump & open the inlet valve.

-Make sure the outlet valve is closed.

15) Let the water level rise above the top of the float.

16) Open the outlet valve making sure the hose from the outlet valve is in the drain and not the bucket.

17) Continue flushing with water for 5 minutes.

Note: Additional water may have to be added to the bucket.

18) When flushing is complete, close the 2 ball valves attached to the unit and turn the unit off.

19) Replace the plugs in the ball valves & re-install the lower panel.

20) The unit is now ready for use.

GAS BOILER, CURRENT P10 (DETAIL "B")

1) Remove the plugs.

2) Attach the 3-inch nipples with attached unions to the inlet & outlet ports.

3) Install the 1/2 inch hose with the attached union to the inlet port.

4) Install the the 3/4 hose with the attached union to the outlet port.

5) Open the sliding view port on the right side panel of the unit. This will expose the float.

6) Fill the 5 gallon bucket with descaler.

7) Turn the unit on.

- 8) Turn on the descaler pump. Let the boiler fill with descaler just above the top of the float. This can be determined by watching the level rise in the float.
- 9) As the descaler level in the bucket drops, add water so the pump remains submerged.
Note: liquid level in the descaler bucket should not go below the pump.
- 10) When the descaler reaches the required level, make sure the exit line is in the bucket with the pump. The required level can be maintained by controlling the flow with the ball valves.
- 11) Let the pump run for 1 hour.
- 12) After 1 hour, turn the pump off. Also, turn the main switch to off and let drain.
- 13) Flush the boiler with water when all of the descaler has drained.
- 14) Turn the unit on to fill with water.
 - Fill the 5-gallon bucket with water.
 - When the water level reaches the middle of the sight glass, turn on the pump & open the inlet valve.
 - Make sure the outlet valve is closed.
- 15) Let the water level rise above the top of the float.
- 16) Open the outlet valve making sure the hose from the outlet valve is in the drain and not the bucket.
- 17) Continue flushing with water for 5 minutes.
Note: Additional water may have to be added to the bucket.
- 18) When flushing is complete, turn the unit off.
- 19) Replace the plugs & re-install the lower panel.
- 20) The unit is now ready for use.

REMOVE PLUGS BEFORE
INSTALLING BOILER KIT

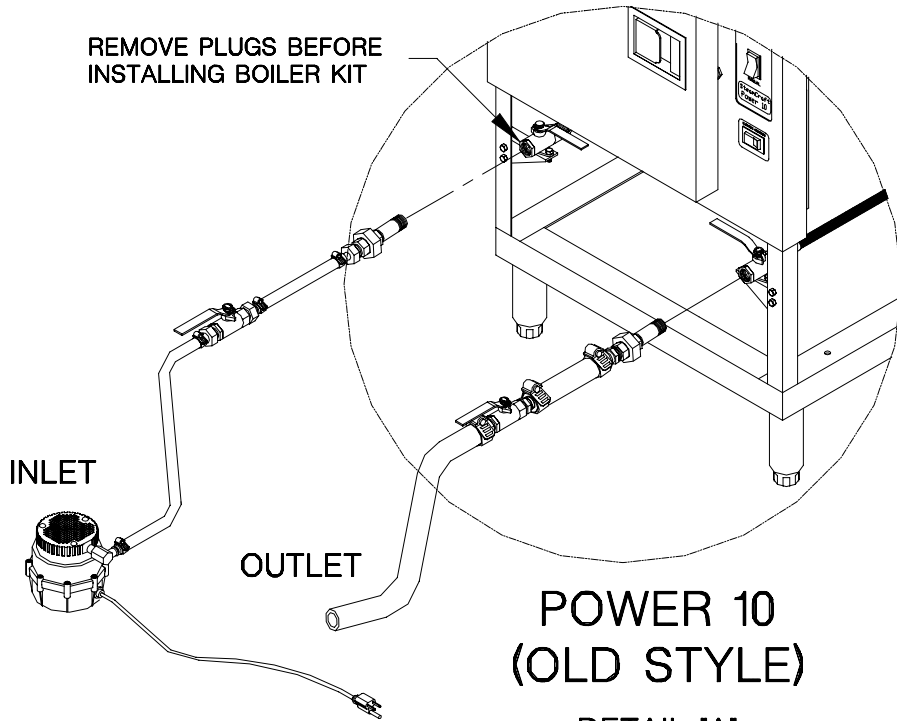

POWER 10 (OLD STYLE)

DETAIL 'A'

DESCALING KIT

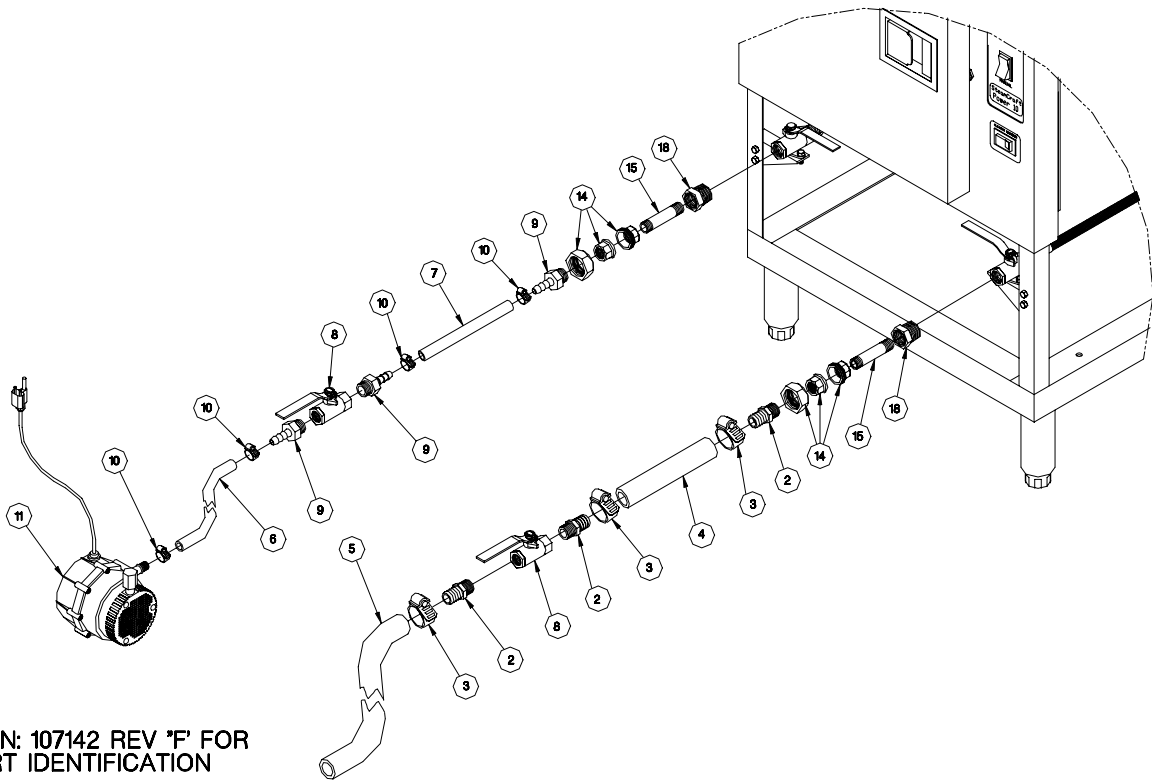

SEE P/N: 107142 REV 'F' FOR
PART IDENTIFICATION

REMOVE PLUGS BEFORE
INSTALLING BOILER KIT

INLET

OUTLET

POWER 10
(CURRENT)

DETAIL "B"

DESCALING KIT

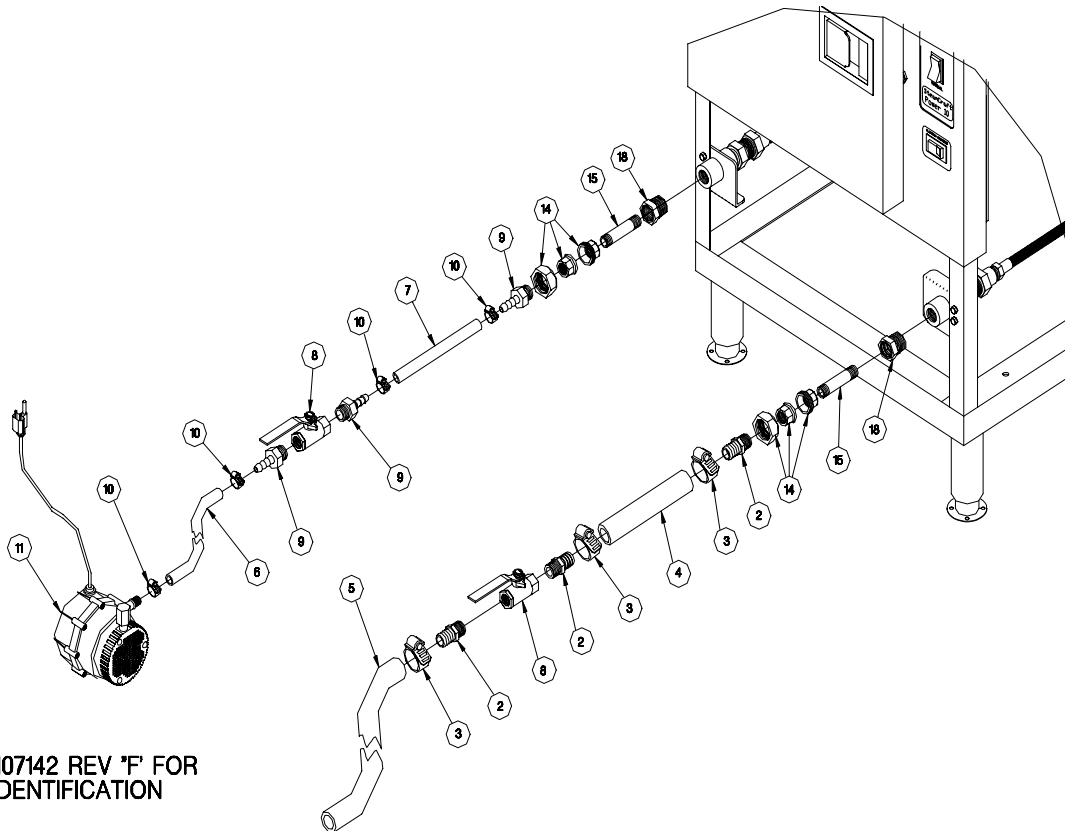

SEE P/N: 107142 REV 'F' FOR
PART IDENTIFICATION

STEAMCRAFT 10 DESCALING KIT PART LIST

(P/N: 107142)

ITEM	PART #	DESCRIPTION	QTY
1	437481	Plate Ass'y, Handhole w/Descaler Port	1
2	06241	Fitting, Hose Barb, 3/4 H x 1/2 MPT	3
3	03204	Clamp, Hose, Worm Drive	3
4	1088190600	3/4 Hose For Descaling Syst, 6.000" Lg	1
5	1088193600	3/4 Hose For Descaling Syst, 36.000" Lg	1
6	1088203600	1/2 Hose For Descaling Syst, 36.000" Lg	1
7	1088200600	1/2 Hose For Descaling Syst, 6.000" Lg	1
8	22212	Valve, Ball, 1/2 Female	2
9	06237	Fitting, Hose, Barb, 1/2H X 1/2 MPT	3
10	106219	Clamp, Hose Worm Drive	4
11	107131	Pump, Submersible, Boiler Descaler Kit	1
12	07106	Gasket, Handhole	1
13	107199	Bucket W/Lid, 5 Gallon	1
14	23103	Union, 0.500, Brass	2
15	14331	Nipple, 0.500 NPT x 2.500 Lg, Sch 40	2
16	108815	Label, Descaling System	1
17	108845	Envelope, Vinyl, 10" x 13", Short Side Opening	1
18	02566	Bushing, Reducing, 3/4 x 1/2	2
19	41943	Plate Ass'y, Mounting, Weldment	1
20	260 ALK	Instructions, Descaling Installation	1
21	260 ALP	Instructions, Piping Conversion	1